



**YOUR  
SOLUTIONS**

C O R R O S I V E   A P P L I C A T I O N S

# User manual

## Installation

## Operation

## Maintenance

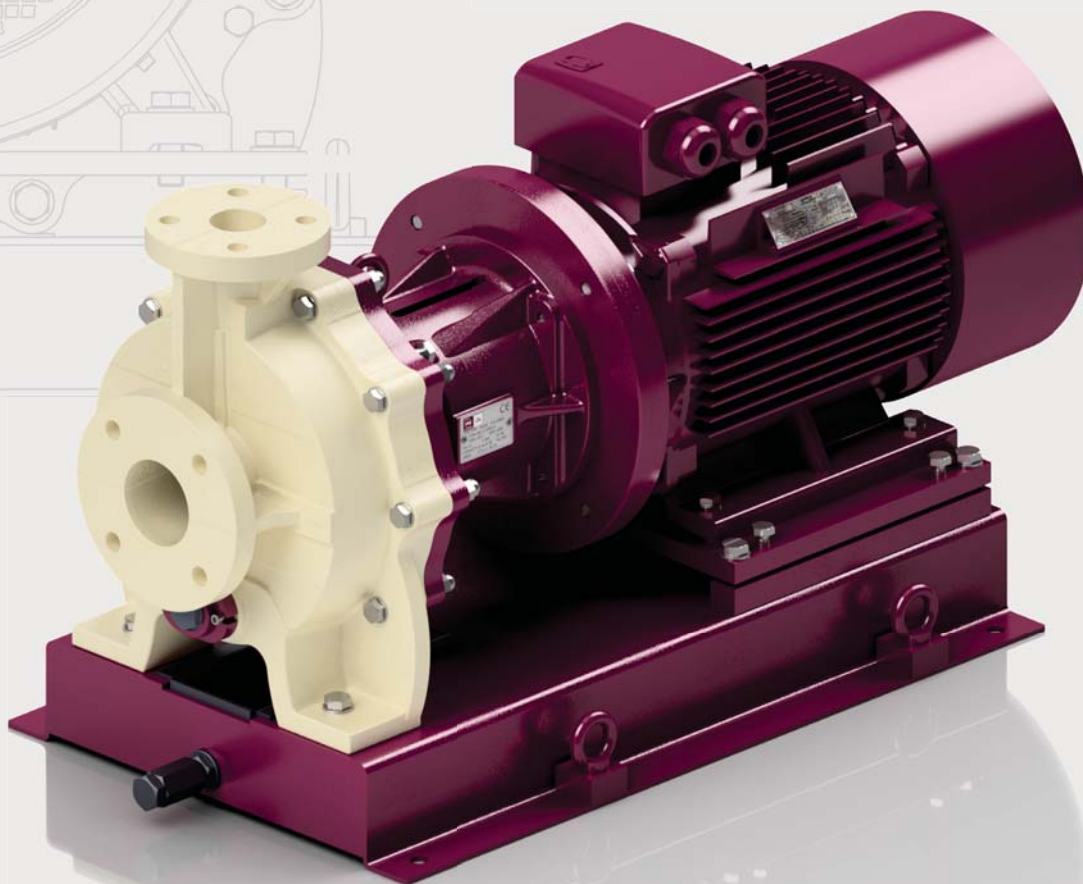

User manual in the original or in different languages should be requested to the manufacturer.

ISO 9001:2015  
Certified company



2006/42/EC  
Machinery Directive



HAM-002ENX  
Translation of the  
original instructions

Close coupled centrifugal pumps  
with mechanical seal

# CFM

# Index

|   |           |
|---|-----------|
| <b>1.0 GENERAL</b>                                | <b>3</b>  |
| 1.1 EC CONFORMITY DECLARATION                     | .3        |
| 1.2 GENERAL INFORMATION                           | .3        |
| 1.3 DISCLAIMER AND RIGHTS                         | .3        |
| 1.4 DESCRIPTION OF CFM RANGE                      | .3        |
| 1.5 PUMP CODE                                     | .3        |
| 1.6 SERIAL NUMBER                                 | .3        |
| 1.7 MARKING                                       | .3        |
| 1.8 CERTIFICATIONS                                | .3        |
| 1.9 DOCUMENTATION                                 | .4        |
| 1.10 WARRANTY                                     | .4        |
| 1.11 SAFETY                                       | .4        |
| <b>2.0 PUMP DESCRIPTION</b>                       | <b>5</b>  |
| 2.1 MAIN PARTS                                    | .5        |
| 2.2 MAXIMUM OPERATING SPEEDS                      | .6        |
| 2.3 MAXIMUM PRESSURES                             | .6        |
| 2.4 MINIMUM OPERATING FLOW RATES                  | .6        |
| <b>3.0 TRANSPORT AND STORAGE</b>                  | <b>6</b>  |
| 3.1 PACKING                                       | .6        |
| 3.2 TRANSPORT, HANDLING AND HOISTING              | .6        |
| 3.3 INSPECTION                                    | .9        |
| 3.4 STORAGE                                       | .9        |
| <b>4.0 INSTALLATION</b>                           | <b>9</b>  |
| 4.1 LOCATION OF THE PUMP                          | .9        |
| 4.2 SUPPORT BASEPLATE AND FOUNDATIONS             | .9        |
| 4.3 PIPING  | 10        |
| 4.4 SUCTION PIPING                                | 10        |
| 4.5 DISCHARGE PIPING                              | 10        |
| 4.6 FILLING PIPING                                | 11        |
| 4.7 DRAINAGE PIPING                               | 11        |
| 4.8 FITTINGS                                      | 11        |
| 4.9 CONTROL INSTRUMENTS                           | 11        |
| 4.10 FINAL CHECK                                  | 12        |
| 4.11 CONNECTION OF THE ELECTRIC MOTOR             | 12        |
| 4.12 CONNECTION OF THE INTERNAL COMBUSTION ENGINE | 12        |
| 4.13 EXAMPLE OF INSTALLATIONS                     | 14        |
| <b>5.0 OPERATION</b>                              | <b>18</b> |
| 5.1 DIRECTION OF ROTATION                         | 18        |
| 5.2 PRELIMINARY PUMP TESTING                      | 18        |
| 5.3 FLUSHING                                      | 18        |
| 5.4 PRELIMINARY MOTOR TESTING                     | 18        |
| 5.5 START-UP                                      | 18        |
| 5.6 OPERATION                                     | 18        |

|                      |    |
|----------------------|----|
| 5.7 SHUTDOWN         | 18 |
| 5.8 TEMPERATURES     | 19 |
| 5.9 FLOW RANGE       | 19 |
| 5.10 VIBRATION LEVEL | 19 |
| 5.11 NOISE LEVEL     | 19 |

## 6.0 MAINTENANCE 19

|  |    |
|--|----|
| 6.1 PREVENTIVE MAINTENANCE                               | 19 |
| 6.2 MAINTENANCE INSTRUCTION                              | 20 |
| 6.3 DAILY INSPECTION AND MAINTENANCE                     | 20 |
| 6.4 SIX-MONTHLY INSPECTION AND MAINTENANCE               | 20 |
| 6.5 EXTRAORDINARY MAINTENANCE                            | 20 |
| 6.6 CRYSTALLIZATION OF PUMPED LIQUID                     | 20 |
| 6.7 DRAINING AND CHANGING THE PUMPED LIQUID              | 20 |
| 6.8 DRY RUN OPERATION                                    | 21 |
| 6.9 IMPURITIES CONTAINED IN THE PUMPED LIQUID            | 21 |
| 6.10 RECOMMENDED SPARE PARTS                             | 21 |
| 6.11 MINOR CRACKING AND HOLES REPAIRING FOR FRP MATERIAL | 21 |
| 6.12 DISPOSAL  | 21 |
| 6.13 RETURNING OF THE PUMP UNIT                          | 21 |
| 6.14 DISASSEMBLY OF THE PUMP UNIT                        | 21 |
| 6.15 ASSEMBLY OF THE PUMP UNIT                           | 23 |
| 6.16 PUMP-MOTOR AXIS ALIGNMENT                           | 25 |
| 6.17 CAUSES OF TROUBLE AND TROUBLESHOOTING               | 27 |

## 7.0 COMPONENTS LIST 28

|   |    |
|---|----|
| 7.1 EXPLODED VIEW   | 28 |
| 7.2 SECTIONAL VIEW WITH JRS / JRS1 MECHANICAL SEAL                | 30 |
| 7.4 B6EDF - B6EDFC - B6E - B6EC - B6EFL - B6EFLC SEALS            | 32 |
| 7.5 JRS - JRS1 - JTP - JRA - JRG SEALS                            | 33 |
| 7.6 JR2S - JR2S1 - JT2P - JR2A - JR2G SEALS                       | 34 |
| 7.7 B6IDF-B6IDFC-B6IDFH-B6I-B6IC-B6IFL-B6IH-B6IFLH-B6IFLC SEALS35 |    |
| 7.8 J5H - J5G - UMS - UMG - UMD SEALS                             | 36 |

## 8.0 AUXILIARY COMPONENTS 38

|  |    |
|--|----|
| 8.1 SYMBOLS LEGEND AND NOTES                       | 38 |
| 8.2 FLUSHING SYSTEM FOR SINGLE SEAL: API PLAN 7301 | 38 |
| 8.3 FLUSHING SYSTEM FOR SINGLE SEAL: API PLAN 7311 | 38 |
| 8.4 FLUSHING SYSTEM FOR SINGLE SEAL: API PLAN 7312 | 38 |
| 8.5 FLUSHING SYSTEM FOR SINGLE SEAL: API PLAN 7332 | 39 |
| 8.6 FLUSHING SYSTEM FOR DOUBLE SEAL: API PLAN 7352 | 39 |
| 8.7 FLUSHING SYSTEM FOR DOUBLE SEAL: API PLAN 7353 | 39 |
| 8.8 FLUSHING SYSTEM FOR DOUBLE SEAL: API PLAN 7354 | 40 |

## 9.0 OUTER DIMENSIONS 41

|                                 |    |
|---------------------------------|----|
| 9.1 DIMENSIONS OF THE PUMP UNIT | 41 |
|---------------------------------|----|

## 1.0 GENERAL

### 1.1 EC CONFORMITY DECLARATION

Manufacturer:  
 Affetti Giuseppe & C. s.n.c.  
 Via P. Maroncelli, 4  
 21053 Castellanza (VA) ITALY

The manufacturer declares that the pump unit CFM in the standard designs and supplied with a drive (electric motor or internal combustion engine) and baseplate, complies with the 2006/42/EC Machinery Directive.

Applied harmonized standards:

- EN ISO 12100:2010 General principles for design
- EN ISO 809:2009 Pumps and pump units for liquids

Conformity to the directives and standards listed above is subject to the condition that the pump unit is used in accordance with the conditions of service contractually agreed, this responsibility belong to the end-user.

Any modification to the machine or its use not contractually agreed or not approved in writing by the manufacturer will make null and void this declaration.

The pump unit to which this declaration refers may only be put into operation after they have been installed as specified by the manufacturer and after that the complete system or plant of which these pumps form part complies with the requirements of the Directive 2006/42/EC.

In case of supply of partly completed pump, the purchaser / user must provide the assembly of the pump unit (pump, drive and baseplate) according the manufacturer's instructions and verify the compliance to the Directive 2006/42/EC before to put the machinery into operation.

### 1.2 GENERAL INFORMATION

This manual is written to ensure safe handling of the equipment and its intended use. The equipment must be operated in compliance with these instructions in order to ensure reliability and avoid any risk.

The user / operator must follow the national standards and safety regulations in force, even if they have not been mentioned in this manual.

**This information must always be kept close to where the pump is installed or attached to the pump itself.**

**The user manual must be read and analysed before installing, operating or carrying out any maintenance work on the pump unit.**

**Failure to comply with the instructions contained in this manual may cause danger to personnel and will void the AFFETTI warranty.**

The instructions and information contained in this user manual are only valid for the pump to which the manual is attached. They do not apply to the plant in which the pump unit will be installed.

### 1.3 DISCLAIMER AND RIGHTS

Information contained in this manual is deemed reliable. The manufacturer shall not be held responsible in the event that, despite their efforts to supply exhaustive and consistent information, the contents of this manual prove to be insufficient. The purchaser/user must check the information contained in this instruction manual and contact the manufacturer for any missing information.

All rights reserved. No part of this manual may be reproduced, stored in any type of system or transmitted in any form whatsoever, nor by any means, without prior authorisation from the manufacturer.

The manufacturer reserves the right to make changes to the structure of the pump without updating previous supplies.

### 1.4 DESCRIPTION OF CFM RANGE

The CFM range of close coupled pumps in fibreglass material, has been developed to be installed horizontally and for pumping seawater or low-corrosive liquids. They are intended to be installed in a suitable plant or system. Special attention has been dedicated to heavy construction, easy access for

maintenance and hydraulic efficiency. Each pump is combined with a series of motors of different power ratings and satisfies the most varied needs thanks to an optimum ratio between flow and total head in relation to the specific gravity of the pumped liquid, guaranteeing low energy consumption.

### 1.5 PUMP CODE

The pump code identifies the pump and construction materials.

| Code    | Description                     |
|---------|---------------------------------|
| CFM     | Name of series                  |
| 6x4x13  | Size of pump                    |
| FRP-VES | Material of casing and impeller |
| EPDM    | Material of O-rings             |
| 55 kW   | Motor output                    |

TABLE 1.5.1: Identification codes

### 1.6 SERIAL NUMBER

The serial number is a sequential number used to identify every pump manufactured. It is marked on the pump's tag plate.

### 1.7 MARKING

Each pump is equipped with a tag plate marked with all of the data required in accordance with the 2006/42 EC Machinery Directive, which also facilitates identification of the pump. For any spare part requests, should be provided the data marked on the pump's tag plate or the serial number.

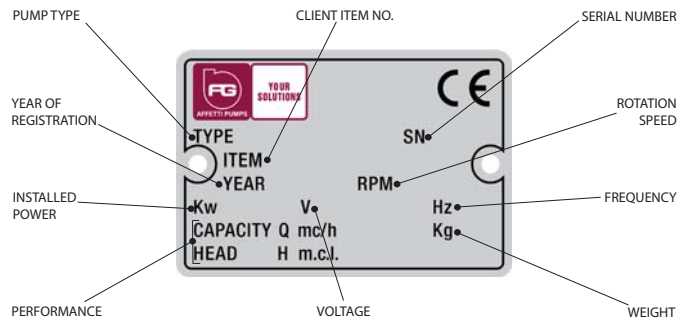

**NOTE:** The weight indicated on the tag-plate of the pump refers to the weight of the pump unit (pump, drive and baseplate). Detailed weights of the single parts are shown in this manual (see table 3.2.4).

**NOTE:** In case of supply of partly completed pump, the weight indicated refers only to the parts provided. For safety reasons, the purchaser / user must provide the permanently fixing of an additional tag-plate indicating the total weight of the pump unit (pump, drive and baseplate) complies with the Directive 2006/42/EC.

### 1.8 CERTIFICATIONS

Certifications supplied as standard are:

- 2006/42/EC conformity declaration
- Warranty certificate
- Pump data sheet

Certifications available on request are:

- Certificate of origin
- Certificate of origin for materials
- Material conformity certificate
- Impeller balancing certificate
- Pump shaft balancing certificate
- Hydrostatic test
- Functional test without data recording
- Visual examination and dimensional test
- Vibration measurement (at contractual point)
- A-weighted sound pressure (at contractual point)
- Strip down certificate
- Performance test with report (Q-H-Na-%)
- Performance test with report (Q-H-Na-%-NPSHr)

## 1.9 DOCUMENTATION

The following documentation is attached to the user manual:

- Cross sectional drawing of the pump
- User manual of the motor
- User manual of the mechanical seal

**NOTE:** If the above documents were not shipped or sent, they should be required to the manufacturer.

## 1.10 WARRANTY

The products are guaranteed by our company in so far as they are of our manufacture. Manufacturing or material defects are covered by the warranty for a period of up to one year from the date of dispatch from our factory (data of invoice) and not more than six months from the date of installation. During this period the manufacturer undertakes to substitute and repair free of charge any appliance found to have been faulty from the start due to manufacturing or material defects.

The warranty provides for the substitution of faulty parts, but only after an investigation has been conducted to prove that any damage to the pump was not caused by external factors, but purely and exclusively by construction faults.

The manufacturer shall not be held liable for damages caused by dry operation, faulty assembly of the pump and/or plant, foreign bodies entering the pump, the use of liquids other than those declared by the purchaser, variations in flow rate, total head or temperature compared to the data indicated at the time of order, water hammer, transport (in the event that the goods travel at the customer's own risk), works carried out by unskilled personnel, etc.

The warranty does not cover direct or indirect compensation for damages caused by our pump to objects or persons or during repair work performed by the purchaser or third parties.

The product will not be covered by the warranty if the customer tampers with it by repairing or even manipulating it without our prior agreement.

The use of any parts or accessories supplied by a third party will render the manufacturer warranty null and void.

The warranty conditions also require that the appliance be forwarded to our factory suitably packed and that after its replacement or repair it be dispatched to the customer with transport and packing charges at their expense.

The manufacturer does not accept liability for our products unless the customer strictly observes all of the contractual clauses.

Work performed under warranty will not affect the warranty period.

Parts subject to wear are not covered by the warranty.

**Non-compliance with the indications and instructions given in this manual will void the warranty.**

## 1.11 SAFETY

**All personnel involved in operation, installation, inspection and maintenance of the pump must be qualified for the job.**

If the personnel are not already qualified for the intended job, the user shall ensure that they receive appropriate training. On request from the operator, the user may ask the manufacturer/supplier to arrange appropriate training which should be appropriately priced and agreed upon according to the formal request.

All original parts and accessories have been designed, tested and incorporated to guarantee the quality of the end product and continuity of the performance characteristics. The use of parts and accessories supplied by third parties may have a negative effect on the performance characteristics and product safety. Damage or failure caused by improper use are not covered by the warranty. Furthermore, any changes made to the equipment or removal of the original components may impair the safety of these products during operation.

This manual contains specific safety symbols, as described here below. Non-observance of the instructions related to the various symbols will result in the creation of a hazardous situation.



This Hazard symbol indicates safety measures regarding electrical parts. Non-observance of these instructions could pose a serious safety risk for people.



This warning symbol indicates safety measures. Non-observance of

these instructions could pose a safety risk for people.



This warning symbol indicates safety measures. Non-observance of these instructions could pose a safety risk for people and the operation of equipment and could result in damage to property.



This symbol indicates important instructions that must be followed.

**Some important instructions related to safety are given here below:**



Beware of the liquid pumped, avoiding any contact.



**The pumps of this series are used to transfer dangerous chemicals. The operators should be equipped with appropriate equipment during all procedures of installation, operation and maintenance. Rubber boots, anti-acid overalls and a helmet with a protective visor for the face are essential requirements to allow operators to work without risking their physical safety.**



In the event of leakages of corrosive or hot liquid immediate actions to avoid the any contact, such as the evacuation of the area, must be taken. The corrosive liquid must be removed by authorized companies in accordance with national laws and regulations.



Never touch the pump if the liquid pumped exceeds +70°C. Wait until the pump cools down before performing any work.



When handling a toxic liquid, ventilate the working area.



Do not drain the pumped liquid out of the casing directly onto the ground. Install a pipe system (including a gate valve) to the drainage hole of the casing (if provided) and drain the pumped liquid into a chemically resistant container or reservoir according to the laws and regulations related to the application, handling and processing of hazardous liquids.



For any treatment or intervention on the fiberglass parts the operator must use PPE, such as dust mask, dust musk respirator and protective visor to avoid inhalation of dust produced or contact of skin or face with the harmful or irritating substances.



Do not remove guards and protective devices during the pump operation.



After maintenance works place and fix again all guards and protective devices. All parts must be assembled before the start-up of the pump.



Any rotating part should be freely accessible during the pump operation.



Handle any sharp components with care.



Do not put hands or fingers inside the pump's holes, openings or windows.



Do not stand on the pump or use it as support or step.





Never perform maintenance work when the pump is connected to the power supply. If a switch has been fitted, make sure it is in the "zero" (off) position. Wait until the pump has stopped completely.



Do not remove the end caps from the nozzle of the pump until the installation. Place them again when the pump is removed from the system.



 **CAUTION** Never start the pump without liquid inside the casing.

 **CAUTION** The gate valves in the suction pipe must be fully open when the pump is starting or operating.

 **CAUTION** Comply with the limits of flow and use specified in the order confirmation.

 **CAUTION** Prevent the entry of foreign objects into the pump.

 **CAUTION** Never choke the pipes when the pump is in operation.

 **DANGER** Electrical motor and other devices must be installed according to the safety regulations in force.

 **DANGER** If pump is used on variable speed drive, do not exceed the frequency for which the pump was designed.

 **DANGER** Run the at the specified power supply voltage on the tag plate of the motor.

 **DANGER** Install an earth leakage breaker.

 **DANGER** Arrange grounding.

## 2.0 PUMP DESCRIPTION

### 2.1 MAIN PARTS

#### 2.1.1 Casing

The casing is equipped with a volute and the suction inlet and delivery outlet are in an axial position, thereby meeting standard plant requirements. It has flanged connections according to ANSI/ASME B16.5 class 150 FF (according to ISO on request). In the lowest area of the casing is provided on request a threaded hole to allow the complete drainage of any liquid remaining in the pump.

#### 2.1.2 Impeller

The impeller is the semi-open type; the blades on the rear side reduce the axial thrust caused by the flow of liquid during the working operation. Its size depends on the performance required.

#### 2.1.3 Shaft

The shaft transmits to the impeller the rotary motion generated by the drive. It is connected directly to the drive.

#### 2.1.4 Gland

The gland contains the mechanical seal. On request it is provided with a threaded connection on the bottom in order to connect a pipe system to evacuate eventually leakages of liquid from the mechanical seal. For double mechanical seals it is provided with two threaded connections on the sides to inject the auxiliary liquid (see chapter 8).

#### 2.1.5 Mechanical seals

The mechanical seal prevents fluid leaks from the pump. Various types and brands of seals can be used. The selection is made at the time of offer according to the pump's operating conditions and compatibility with the liquid pumped.

 **CAUTION** The mechanical seal must never be run dry.

**NOTE:** The seal does not require auxiliary lubrication with oil or grease.

**NOTE:** The working lengths of mechanical seals are indicated on pages 32-36.

#### 2.1.6 Frame

The heavy construction frame consists of a single piece purposely designed to support the pump and protect the rotating parts.

The frame size or group depends on the pump model as indicated below:

| Pump model             | Group (Frame) |
|------------------------|---------------|
| 1.5x1x6 (40x25x150)    | I             |
| 3x1.5x6 (80x40x150)    | I             |
| 1.5x1x8 (40x25x200)    | I             |
| 3x2x6 (80x50x150)      | I             |
| 3x1.5x8 (80x40x200)    | II            |
| 3x2x8 (80x50x200)      | II            |
| 4x3x8 (100x80x200)     | II            |
| 3x1.5x10 (80x40x250)   | II            |
| 3x2x10 (80x50x250)     | II            |
| 4x3x10 (100x80x250)    | II            |
| 6x4x10 150x100x250)    | II            |
| 3x2x13 (80x50x330)     | II            |
| 4x3x13 (100x80x330)    | II            |
| 6x4x13 (150x100x330)   | II            |
| 8x6x13 (200x150x330)   | III           |
| 10x8x13 (250x200x330)  | III           |
| 8x6x15 (200x150x380)   | III           |
| 10x8x15 (250x200x380)  | III           |
| 12x10x16 (300x250x400) | III           |

TABLE 2.1.6.1: Frame sizes or groups.

#### 2.1.7 Baseplate

The baseplate is in electro-welded carbon steel (S235JR) or in sheet metal steel (SS304). On request, the baseplate can be provided with a regulation system to align the drive.

 **CAUTION** The baseplate is provided (on request) with a drip-pan for pump leakages. The drip-pan has a drain hole that should be connected to a drainage piping with a check valve. Leakages should be conveyed in a chemically resistant reservoir. The leakages level must never exceed the maximum capacity of the drip-pan.

#### 2.1.8 Drive

The motors installed comply with the IEC standards (NEMA on request), have an IP55 protection rating and are built in insulation class F, unless other special requirements apply.

**NOTE:** On request the pump can be provided with an internal combustion engine.

**NOTE:** The user manual of the drive is provided with the goods. It has the same importance of the user manual of the pump and should be read and analysed before all operations.

## 2.2 MAXIMUM OPERATING SPEEDS

| Pump model             | Max. RPM |
|------------------------|----------|
| 1.5x1x6 (40x25x150)    | 3500     |
| 3x1.5x6 (80x40x150)    | 3500     |
| 1.5x1x8 (40x25x200)    | 3500     |
| 3x2x6 (80x50x150)      | 3500     |
| 3x1.5x8 (80x40x200)    | 3500     |
| 3x2x8 (80x50x200)      | 3500     |
| 4x3x8 (100x80x200)     | 3500     |
| 3x1.5x10 (80x40x250)   | 3500     |
| 3x2x10 (80x50x250)     | 3500     |
| 4x3x10 (100x80x250)    | 3500     |
| 6x4x10 150x100x250)    | 3500     |
| 3x2x13 (80x50x330)     | 1780     |
| 4x3x13 (100x80x330)    | 1780     |
| 6x4x13 (150x100x330)   | 1780     |
| 8x6x13 (200x150x330)   | 1780     |
| 10x8x13 (250x200x330)  | 1780     |
| 8x6x15 (200x150x380)   | 1780     |
| 10x8x15 (250x200x380)  | 1780     |
| 12x10x16 (300x250x400) | 1780     |

TABLE 2.2.1: Maximum operating speeds.

## 2.3 MAXIMUM PRESSURES

The maximum pressure (including the hydrostatic test) is equal to 1.5 times the maximum working pressure at the duty point (specified on the purchase order). Higher factor or different conditions must be agreed with the manufacturer.

 Apply higher pressures than those agreed could pose a safety risk for people and the operation of equipment and could result in damage to property.

## 2.4 MINIMUM OPERATING FLOW RATES

The minimum flow value (continuous flow) must be maintained with regard to the pump's best efficiency point (BEP) as indicated in the following table:

| Pump model           | % BEP     |           |
|----------------------|-----------|-----------|
|                      | 2950-3500 | 1480-1780 |
| 1.5x1x6 (40x25x150)  | 15%       | 10%       |
| 3x1.5x6 (80x40x150)  | 15%       | 10%       |
| 3x2x6 (80x50x150)    | 20%       | 10%       |
| 1.5x1x8 (40x25x200)  | 20%       | 10%       |
| 3x1.5x8 (80x40x200)  | 20%       | 10%       |
| 3x2x8 (80x50x200)    | 20%       | 10%       |
| 4x3x8 (100x80x200)   | 20%       | 10%       |
| 3x1.5x10 (80x40x250) | 25%       | 10%       |
| 3x2x10 (80x50x250)   | 30%       | 15%       |
| 4x3x10 (100x80x250)  | 30%       | 15%       |
| 6x4x10 150x100x250)  | 40%       | 20%       |
| 3x2x13 (80x50x330)   | N/D       | 15%       |
| 4x3x13 (100x80x330)  | N/D       | 40%       |
| 6x4x13 (150x100x330) | N/D       | 40%       |
| 8x6x13 (200x150x330) | N/D       | 40%       |

|                        |     |     |
|------------------------|-----|-----|
| 10x8x13 (250x200x330)  | N/D | 40% |
| 8x6x15 (200x150x380)   | N/D | 50% |
| 10x8x15 (250x200x380)  | N/D | 50% |
| 12x10x16 (300x250x400) | N/D | 50% |

TABLE 2.4.1: Minimum operating flow rates (continuous flow).

**NOTE:** The maximum flow value must not exceed 125% of the pump's best efficiency point (BEP).

**NOTE:** If the flow rate required is less than the minimum flow rate, the equipment must be equipped with a by-pass system in order to guarantee the return of excess liquid from the discharge pipe (before the gate valve) to the suction reservoir.

## 3.0 TRANSPORT AND STORAGE

### 3.1 PACKING

The packaging structure and materials are chosen according to shape, dimensions and weight of the good to be shipped.

The following procedure should be followed on receipt of the goods:

1. Check that the contents correspond with that specified on the transport document and your order.
2. Check whether the packaging shows any sign of damage that may have occurred during transport.
3. Carefully remove the contents from the packaging.

**NOTE:** If the pump unit has been damaged during transport, save the packaging and notify the forwarder immediately. Furthermore, contact the manufacturer to check product functionality.

### 3.2 TRANSPORT, HANDLING AND HOISTING

Great care must be taken with transport as it is a delicate operation and very important for the correct operation of the pump unit.

Loading and unloading of the goods must be performed taking into account the shape, weight and nature of the packaging.

Hoisting should be done without putting any stress on the pump's most fragile parts (fiberglass parts and connections). The packed pump unit should be set down gently and without knocking it and it must be fixed and supported so that it does not move from its original position and is not exposed to strong vibrations during transport.

Unloading at the customer's premises must be performed with the same precautions taken for loading.

Instructions for transport, handling and hoisting are given here below:

- Before handling, check the weight, size and centre of gravity of the component (provided on request) to be handled (see table 3.2.4).
- If the pump unit needs to be moved after it has been installed, make sure that the pump has been drained (if drainage hole is provided).
- Always hoist the pump unit from the recommended hoisting points (see illustrations).
- Always hoist the pump horizontally, never vertically.
- The ropes or slings must not create an angle greater than 90°.

 Never pass below a hoisted load.

 Use oversized lifting gears appropriate for the total weight to be transported.

 For loads greater than the manual handling (including spare parts) use a suitable, type-tested hoisting system that is in good condition connected to rings, eyebolts, holes or threaded terminals of the part to lift. Goods must only be handled by suitably trained personnel, according to the relevant regulations in force.

 Safety systems and protective equipment such as gloves, helmets and safety shoes must be used to protect personnel during goods handling.

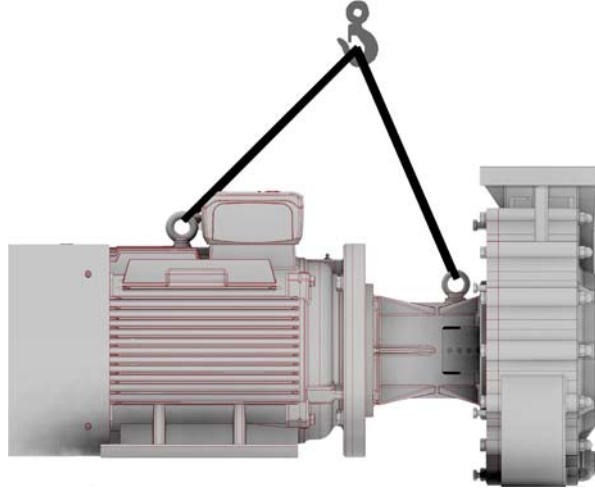

ILLUSTRATION 3.2.1: Hoisting a pump unit without baseplate.

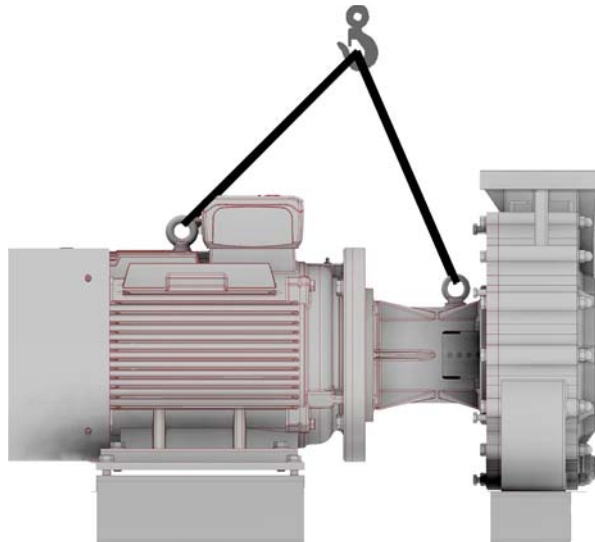

ILLUSTRATION 3.2.2: Hoisting a pump unit with sheet metal baseplate.

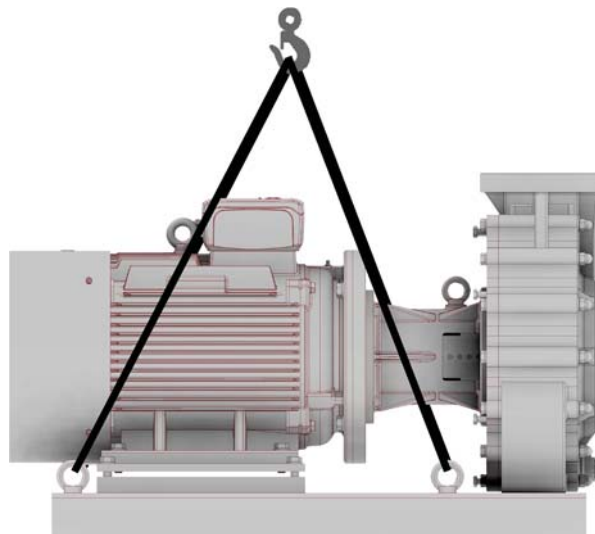

ILLUSTRATION 3.2.3: Hoisting a pump unit with welded baseplate.

| Weight of components in Kg   |             |                             |                   |                        |                        |      |      |  |
|--|-------------|-----------------------------|-------------------|------------------------|------------------------|------|------|--|
| Model  | Motor frame | Pump weight (without motor) | Base-plate weight | Motor weight (2 poles) | Motor weight (4 poles) |      |      |  |
| 1.5x1x6 (40x25x150)<br>1.5x1x8 (40x25x200)<br>3x1.5x6 (80x40x150)<br>3x2x6 (80x50x150) | 80          | 15                          | 22                | -                      | 11.4                   |      |      |  |
|  | 90 S        |                             |                   | 13.5                   | 14.5                   |      |      |  |
|  | 90 L        |                             |                   | 15.5                   | 17                     |      |      |  |
|  | 100 L       |                             |                   | 23.4                   | 26.5                   |      |      |  |
|  | 112 M       |                             |                   | 28.8                   | 35                     |      |      |  |
|  | 132 S       |                             |                   | 47.7                   | 48.5                   |      |      |  |
|  | 160 M       |                             | 27                | 118                    | -                      |      |      |  |
|  | 160 L       |                             |                   | 138                    | -                      |      |      |  |
|  | 180 M       |                             |                   | 163                    | -                      |      |      |  |
|  | 200 L       |                             |                   | 247                    | -                      |      |      |  |
|  | 90 S        |                             |                   | 27                     | 39                     | -    | 14.5 |  |
|  | 90 L        |                             |                   |                        |                        | -    | 17   |  |
| 100 L  | -           | 26.5                        |                   |                        |                        |      |      |  |
| 112 M  | -           | 35                          |                   |                        |                        |      |      |  |
| 132 S  | 41          | 47.7                        | 48.5              |                        |                        |      |      |  |
| 160 M  | 53          | 118                         | -                 |                        |                        |      |      |  |
| 160 L  |             | 138                         | -                 |                        |                        |      |      |  |
| 180 M  |             | 163                         | -                 |                        |                        |      |      |  |
| 200 L  |             | 247                         | -                 |                        |                        |      |      |  |
| 225 M  | 60          | 339                         | -                 |                        |                        |      |      |  |
| 3x1.5x8 (80x40x200)<br>3x1.5x10 (80x40x250)  | 100 L       | 30                          | 39                |                        | -                      | 26.5 |      |  |
|  | 112 M       |                             |                   |                        | -                      | 35   |      |  |
|  | 132 S       |                             |                   | -                      | 48.5                   |      |      |  |
|  | 132 M       |                             |                   | -                      | 62                     |      |      |  |
|  | 160 M       |                             | 50                | 118                    | 123                    |      |      |  |
|  | 160 L       |                             |                   | 138                    | -                      |      |      |  |
|  | 180 M       |                             |                   | 163                    | -                      |      |      |  |
|  | 200 L       |                             |                   | 247                    | -                      |      |      |  |
|  | 225 M       |                             | 60                | 339                    | -                      |      |      |  |
|  | 250 M       |                             |                   | 427                    | -                      |      |      |  |
|  | 280 S       |                             |                   | 580                    | -                      |      |      |  |
|  | 280 M       |                             |                   | 630                    | -                      |      |      |  |
| 315 S  | 73          | 713                         | -                 |                        |                        |      |      |  |
| 3x2x8 (80x50x200)<br>3x2x10 (80x50x250)  | 100 L       | 30                          | 39                | -                      | 26.5                   |      |      |  |
|  | 112 M       |                             |                   | -                      | 35                     |      |      |  |
|  | 132 S       |                             |                   | -                      | 48.5                   |      |      |  |
|  | 132 M       |                             |                   | -                      | 62                     |      |      |  |
|  | 160 M       |                             | 50                | 118                    | 123                    |      |      |  |
|  | 160 L       |                             |                   | 138                    | -                      |      |      |  |
|  | 180 M       |                             |                   | 163                    | -                      |      |      |  |
|  | 200 L       |                             |                   | 247                    | -                      |      |      |  |
|  | 225 M       |                             | 60                | 339                    | -                      |      |      |  |
|  | 250 M       |                             |                   | 427                    | -                      |      |      |  |
|  | 280 S       |                             |                   | 580                    | -                      |      |      |  |
|  | 280 M       |                             |                   | 630                    | -                      |      |      |  |
| 315 S  | 73          | 713                         | -                 |                        |                        |      |      |  |
| 4x3x8 (100x80x200)<br>4x3x10 (100x80x250)  | 100 L       | 57                          | 39                | -                      | 26.5                   |      |      |  |
|  | 112 M       |                             |                   | -                      | 35                     |      |      |  |
|  | 132 S       |                             |                   | -                      | 48.5                   |      |      |  |
|  | 132 M       |                             |                   | -                      | 62                     |      |      |  |
|  | 160 M       |                             | 53                | 118                    | 123                    |      |      |  |
|  | 160 L       |                             |                   | 138                    | 141                    |      |      |  |
|  | 180 M       |                             |                   | 163                    | 163                    |      |      |  |
|  | 180 L       |                             |                   | -                      | 173                    |      |      |  |
|  | 200 L       |                             | 60                | 247                    | 231                    |      |      |  |
|  | 225 M       |                             |                   | 339                    | -                      |      |      |  |
|  | 250 M       |                             |                   | 427                    | -                      |      |      |  |
|  | 280 S       |                             |                   | 580                    | -                      |      |      |  |
| 280 M  | 73          | 630                         | -                 |                        |                        |      |      |  |

|   |     |       |     |      |      |     |
|---|-----|-------|-----|------|------|-----|
| 6x4x10 (150x100x250)<br>6x4x13 (150x100x330)  | 107 | 112 M | 39  | -    | 35   |     |
|   |     | 132 S | 41  | -    | 48.5 |     |
|   |     | 132 M |     | -    | 62   |     |
|   |     | 160 M |     | 53   | 118  | 123 |
|   |     | 160 L |     |      | 138  | 141 |
|   |     | 180 M |     |      | 163  | 163 |
|   |     | 180 L |     |      | -    | 173 |
|   |     | 200 L | 56  | 247  | 231  |     |
|   |     | 225 M |     | 339  | -    |     |
|   |     | 250 M |     | 427  | -    |     |
|   |     | 280 S |     | 580  | -    |     |
|   |     | 280 M | 73  | 630  | -    |     |
| 315 S   | 713 | -     |     |      |      |     |
| 315 M   | 780 | -     |     |      |      |     |
| 112 M   | 99  | 39    |     | -    | 35   |     |
| 132 S   |     | 41    | -   | 48.5 |      |     |
| 132 M   |     |       | -   | 62   |      |     |
| 160 M   |     | 53    | -   | 123  |      |     |
| 160 L   |     |       | -   | 141  |      |     |
| 180 M   |     |       | -   | 163  |      |     |
| 112 M   | 104 |       | 39  | -    | 35   |     |
| 132 S   |     | 41    | -   | 48.5 |      |     |
| 132 M   |     |       | -   | 62   |      |     |
| 160 M   |     | 53    | -   | 123  |      |     |
| 160 L   |     |       | -   | 141  |      |     |
| 180 M   |     |       | -   | 163  |      |     |
| 180 L   | -   |       | 173 |      |      |     |
| 8x6x13 (200x150x330)                          | 156 | 225 S | 81  | -    | 338  |     |
|   |     | 225 M |     | -    | 381  |     |
|   |     | 250 M | 87  | -    | 422  |     |
|   |     | 280 S |     | -    | 620  |     |
|   |     | 280 M |     | -    | 695  |     |
|   |     | 315 S |     | -    | 739  |     |
| 10x8x13 (250x200x330)<br>8x6x15 (200x150x380) | 168 | 225 M | 81  | -    | 381  |     |
|   |     | 250 M |     | -    | 422  |     |
|   |     | 280 S | 93  | -    | 620  |     |
|   |     | 280 M |     | -    | 695  |     |
|   |     | 315 S |     | -    | 739  |     |
| 315 M   | -   | 812   |     |      |      |     |
| 10x8x15 (250x200x380)                         | 175 | 250 M | 87  | -    | 422  |     |
|   |     | 280 S |     | -    | 620  |     |
|   |     | 280 M | 93  | -    | 695  |     |
|   |     | 315 S |     | -    | 739  |     |
|   |     | 315 M |     | -    | 812  |     |
|   |     | 315 L |     | -    | 990  |     |
| 12x10x16 (300x250x400)                        | 204 | 280 M | 93  | -    | 695  |     |
|   |     | 315 S |     | -    | 739  |     |
|   |     | 315 M |     | -    | 812  |     |
|   |     | 315 L |     | -    | 990  |     |

TABLE 3.2.4: pump, motor and baseplate masses. The values given are approximate.



### 3.3 INSPECTION

A thorough inspection should be conducted on arrival of the goods. The manufacturer is not responsible for damages to the pump components during the transport. In case damages occurred during transport, the responsible forwarding agent should be contacted.

**NOTE:** For safety reasons some components or accessories may be contained within the main package but packaged separately. Inspect the inside of the case after removing the pump unit.

### 3.4 STORAGE

Dispatched pump unit normally expected to be installed within a brief period of time. If a longer period of storage will be necessary, make sure that the place where the pump unit will be stored is dry, clean, far from sources of vibrations, radiations and inflammable or explosive materials and not exposed to the sun or heat sources to prevent any damage occurring before the equipment is installed.

**CAUTION** The stored pump unit must be protected against humidity and dirt and should not be accessible to unauthorized personnel.

The pump stored after use should not contain any liquid or solid particles. The pump should be internally washed and the fluid drained before storage.

Below general instructions that should be followed:

- Store the pump unit indoors in a package. If the pump unit will be stored outdoors, the packaging must be waterproof and prevent the infiltration of humidity.
- Place the stored pump unit horizontally and cover it with a waterproof canvas.
- Place all equipment upon skids or block to prevent contact with ground or surfaces contaminants and support them to prevent distortion or bending.
- Do not place heavy objects on the packaged products.
- Protect the stored pump unit from splashes or corrosive substances.
- Maintain the temperature in the storage area from +5 °C to +35°C. The storage temperature must always be above the freezing point.
- During storage, once a week, rotate the shaft head manually for at least 5 turns in the direction of rotation (via the fan of the motor removing its rear cover) to prevent the contact faces from seizing up due to friction.
- Do not remove the end plugs on the ports of the pump until ready to install the equipment.
- Clean the pump thoroughly before install it on the plant, eliminating any foreign bodies that could compromise its correct operation.

The motor should be storage according to the manufacturer's instructions.

**NOTE:** The storage instructions must be also applied to the auxiliary components and spare parts.

After a long period of storage elastomeric elements could lose its elastic properties. In this case replace them with new parts.

**NOTE:** On the user request, after a long period of storage or before the installation a manufacturer's representative could be employed to conduct a priced inspection.

**NOTE:** AFFETTI does not accept any liability for defects due to incorrect storage.

## 4.0 INSTALLATION

Read this manual carefully before installation. Personnel performing the installation must be aware of all of the information contained herein. Failure to follow these instructions could cause serious damage to the pump unit, which would no longer be covered by the warranty.

### 4.1 LOCATION OF THE PUMP

**!** The follow operations must only be performed by specialized and trained staff.

The pump unit has to be installed in the best possible position to ensure:

- Easy installation of the suction and discharge pipes.
- Easy access for inspection during normal duty or for maintenance work.
- Proximity to the suction tank or reservoir.
- NPSH available 1 meter greater than NPSH required.

**NOTE:** The ambient temperature should be between +5 and +40 °C and the humidity should not be higher than 85% RH.

**NOTE:** The place of installation must always be clean, well-ventilated and sufficiently lit (with natural or artificial lighting according to 89/654/EEC).

**!** The pump unit should not be installed in earthquake or fire risk areas.

**!** The pump unit installed outdoors should be protected from rain by a roof.

**!** Sufficient safety distance must be kept between the pump unit and any passing people. To ensure the safety of the operator or any other interested party the positioning of the pump should be performed taking into consideration possible ruptures of the parts or leakages of highly corrosive liquid under pressure.

**!** Before installing the pump unit, make sure that the switch is in the "zero" position (OFF) and disconnect the cables from the power supply to avoid the accidental operation of rotating parts.

**NOTE:** Install the pump horizontally with the discharge port on the top.

**NOTE:** If the pump unit is installed in a raised position, take any measures necessary to prevent it or any of its parts from falling over or down whilst in operation. The pump unit must be securely fastened to a firm baseplate. In addition, the installation place should be provided of facilities allowing the secure access to the pump during installation and maintenance works.

### 4.2 SUPPORT BASEPLATE AND FOUNDATIONS

The support baseplate must be made using suitable materials to guarantee the stability of the support and its surrounding area. Foundations in reinforced concrete laid on solid ground are highly recommended. The baseplate must be positioned horizontally, checked using a spirit level and fixed using SS 316 stainless anchor bolts. In case of misalignment between the pump unit and pipes is recommended to use metal shims (SS 316) to even out any differences found when making the connection.

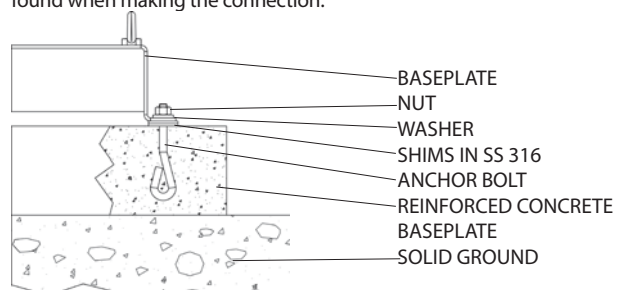



ILLUSTRATION 4.2.1: Example of support baseplate and foundation.

**!** Before putting the pump unit into position, check that the foundation is clean, level and solid, after which carefully rest the baseplate on the foundation so as to prevent misalignment of the pump axis.

 The walking surfaces should be non-slip material.

**NOTE:** The area of the foundations must be greater than the baseplate of the pump.

### 4.3 PIPING

The design of the piping system has a direct effect on the operation of the centrifugal pump. Due consideration must be given to the size of the suction reservoir and both the suction and discharge piping.

**NOTE:** Check that the pump unit is insulated from any external source of vibration. If the pump unit is subject to vibration provide anti-vibration mount.

**NOTE:** Suction and discharge flanges require full flat gaskets with a minimum thickness of 3,2 mm (recommended 5 mm) and hardness of 70 Shore.

 Always check the chemical resistance of the seals to the pumped liquid.

The suction and discharge pipes, connected to the inlets and outlets of the pump, should not produce excessive or disproportionate loads. Excessively high forces and moments transmitted by the pipes may cause damage to the pump. Suction and discharge piping should be well supported and firmly fastened in place. This operation is essential and compulsory for ensuring correct operation of the pump.

The maximum allowable forces and moments to the pump connections are given below (see table 4.3.1 and 4.3.2). Higher values should not be applied to the pump.

| Forces (N) and Moments (N/m) on suction branch |      |     |      |      |     |     |     |     |
|--|------|-----|------|------|-----|-----|-----|-----|
| DN   | Fy   | Fz  | Fx   | ΣF   | My  | Mz  | Mx  | ΣM  |
| 1.5" (40)                                      | 108  | 98  | 123  | 191  | 88  | 103 | 127 | 186 |
| 3" (80)  | 221  | 201 | 245  | 387  | 113 | 127 | 157 | 230 |
| 4" (100)                                       | 294  | 265 | 328  | 515  | 126 | 142 | 172 | 255 |
| 6" (150)                                       | 441  | 397 | 490  | 769  | 172 | 201 | 245 | 358 |
| 8" (200)                                       | 588  | 529 | 657  | 1024 | 225 | 260 | 319 | 470 |
| 10" (250)                                      | 834  | 756 | 935  | 1461 | 353 | 409 | 498 | 734 |
| 12" (300)                                      | 1002 | 902 | 1120 | 1753 | 482 | 554 | 678 | 997 |

TABLE 4.3.1: Forces (N) and Moments (N-m) on suction branch.

NOTE 1: All values of forces and moments are given for the basic material and for temperature of 20°C applied to a new pump unit provided by Affetti and firmly anchored to a solid ground. For different conditions contact the manufacturer.

NOTE 2: ΣF and ΣM are the vector sums of the forces and moments.

| Forces (N) and Moments (N/m) on discharge branch |     |     |     |      |     |     |     |     |
|--|-----|-----|-----|------|-----|-----|-----|-----|
| DN   | Fy  | Fz  | Fx  | ΣF   | My  | Mz  | Mx  | ΣM  |
| 1" (25)  | 69  | 83  | 74  | 127  | 59  | 69  | 88  | 127 |
| 1.5" (40)  | 98  | 123 | 109 | 191  | 88  | 103 | 127 | 186 |
| 2" (50)  | 132 | 162 | 147 | 255  | 98  | 113 | 137 | 201 |
| 3" (80)  | 201 | 245 | 221 | 387  | 113 | 127 | 157 | 230 |
| 4" (100)   | 265 | 328 | 294 | 515  | 123 | 142 | 172 | 255 |
| 6" (150)   | 397 | 490 | 441 | 769  | 172 | 201 | 245 | 358 |
| 8" (200)   | 529 | 657 | 588 | 1024 | 225 | 260 | 319 | 470 |
| 10" (250)  | 756 | 935 | 834 | 1461 | 353 | 409 | 498 | 734 |

TABLE 4.3.2: Forces (N) and Moments (N-m) on discharge branch.

NOTE 1: All values of forces and moments are given for the basic material and for temperature of 20°C applied to a new pump unit provided by Affetti and firmly anchored to a solid ground. For different conditions contact the manufacturer.

NOTE 2: ΣF and ΣM are the vector sums of the forces and moments.

**NOTE:** The pump must not be used to support the piping.

 It must always be checked the parallelism between the pipe and the pump flanges. Incorrect positioning of these parts could cause forced unnatural alignment of the various manifolds connected, which could subsequently cause leaks from the gaskets or even cracks in some sections of piping.

### 4.4 SUCTION PIPING

Sizing of the suction piping is very important. Many problems connected with the operation of centrifugal pumps are caused by incorrect suction conditions.

**NOTE:** Size the suction piping taking into account the NPSH required by the pump so that it is at least 1 m lower than the plant's NPSH available.

Follow the general instructions given below:

- The suction piping should be as short and straight as possible and should have an ascending gradient of 1% toward the pump in suction conditions or descending gradient of 1% toward the pump in flooded conditions.
- Support the piping using brackets built with or coated in material resistant to contact with the liquid and vapours.
- The diameter of the suction pipe must be selected so that a flow velocity of 2,5 m/s of water is not exceeded. In case the diameter of the suction pipe is greater than the suction port install an eccentric reducer before the pump.
- In suction conditions determinate the maximum suction height from the lowest liquid level in the suction tank. Take also into account the viscosity, degree of encrustation and temperature of the liquid.
- Avoid elbows, bottlenecks, sudden reductions or obstructions of any kind. Install only wide radius bends.
- Never fit an elbow directly to the suction port of the pump.
- Avoid any high spots that could create air pockets in the suction pipe.
- Install a gate valve in case of flooded condition of the pump. Maintain the gate valve fully open during the operation. Close it only in case of inspection of the pump.
- Avoid any air infiltration in the suction pipe set carefully the joints between the connections.
- Install a strainer at the end of the suction pipe to prevent foreign matter infiltration in case solid particles are in the liquid. The strainer must be periodically cleaned to prevent restriction.
- Maintain the end of the filling and suction pipes in the suction tank always submerged (see plant recommendations on pages 15-17).
- Maintain a minimum distance between the end of suction pipe and the bottom of the suction tank (see plant recommendations on page 15-17). The distance must be more than 0,5 meter in case of solids particles or mud are on the bottom of the tank.
- Fit a baffle walls into the suction tank to prevent infiltrations or vortices in the suction piping.
- Monitor the minimum level of liquid contained in the priming tank (if provided), preferably using a level probe connected to a solenoid valve for filling up any liquid shortages in the suction tank.
- Install the recommended fittings according to the paragraph 4.8.
- Fit the recommended instrumentations according to the paragraph 4.9.

### 4.5 DISCHARGE PIPING

A check valve and gate valve must be fitted on the discharge piping, together with performance and temperature monitoring instrumentation.

Follow the general instructions given below:

- Support the piping using brackets built with or coated in material resistant to contact with the liquid and vapours.
- Design the discharge pipe calculating the friction losses. Take also into account the viscosity, degree of encrustation and temperature of the liquid.
- The diameter of the discharge pipe must be selected so that a flow velocity of 5 m/s of water is not exceeded. Install and eccentric expansion after the pump if the diameter of the discharge pipe is greater than the discharge port.
- Avoid elbows, bottlenecks, sudden reductions or obstructions of any kind. Install only wide radius bends.
- Never fit an elbow directly to the discharge port of the pump.
- Avoid any high spots that could create air pockets in the discharge pipe.
- Install a air vent piping between the pump and the check valve. The end of the pipe should be open to the atmosphere.

- Fit a drainage line if the liquid might freeze and drain the liquid before each stoppage.
- Install a flushing system to flush the pump before maintenance works.
- Install the recommended fittings according to the paragraph 4.8 .
- Fit the recommended instrumentations according to the paragraph 4.9.

#### 4.6 FILLING PIPING

The filling system is used to fill the suction pipe and the pump in suction conditions with the required amount of liquid before the start-up. The filling system should have a gate valve to isolate the pump and a strainer before the filling port (see plant recommendations on page 15-17).

 The gate valve should be always maintained closed during the operation.

**NOTE:** The strainer should be cleaned periodically.

 Fluid leakages may occur during routine cleaning or replacement of the filter. These operations must be carried out when the pump is not in operation and using appropriate safety equipment.

#### 4.7 DRAINAGE PIPING

The manufacturer provides on request a threaded drainage hole on the lowest area of the casing, with a gaskets and a plug. Belong to the user the responsibility to connect a drainage system to the casing. The drainage system (not provided by the manufacturer) should be used to evacuate the liquid from the casing (after the shutdown) or the drip-pan of the baseplate (in case of leakages) to a chemically resistant reservoir. The drainage system should be connected to the casing and should have a gate valve to isolate the pump (see illustration below or in the plant recommendations on page 15-17). The same recommendations should be followed for the drip-pan of the base.

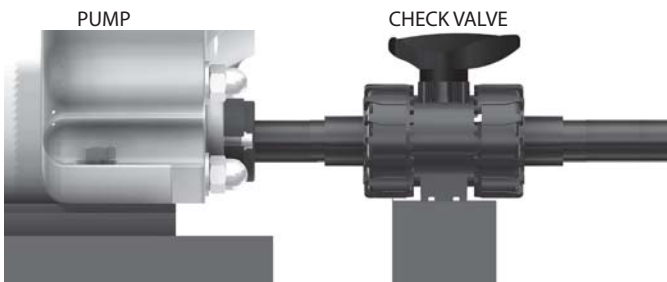

**NOTE:** The drainage hole on the casing and the drip-pan in the baseplate are provided on request.

 The drainage piping and fittings should be made of the same material of the threaded connection.

 The gate valve should be always maintained closed during the operation.

#### 4.8 FITTINGS

To guarantee correct operation in safety conditions the piping should be equipped with the below fittings:

| Recommended fittings |  |                                 |
|----------------------|--|---------------------------------|
| Fitting              | Use  | Location                        |
| Bracket              | To support the pipe.                       | All piping lines.               |
| Strainer             | To reduce the quantity of solid particles. | At the end of the suction pipe. |
| Eccentric reducer    | To avoid air pockets.                      | Before the suction port.        |
| Gate valve           | To isolate the pump in case of inspection. | In the suction line.            |

|                     |   |  |
|---------------------|---|--|
| Flow conditioner    | To minimize swirl and turbulence.   | In the suction piping (after the gate valve).              |
| Strainer            | To reduce the quantity of solid particles.  | After the gate valve and before the filling port.          |
| Gate valve          | To isolate the pump during the operation.   | In the filling line.                                       |
| Strainer            | To reduce the quantity of solid particles.  | After the drainage port and before the gate port.          |
| Gate valve          | To isolate the pump in case of inspection.  | In the drainage line.                                      |
| Eccentric expansion | To avoid air pockets.   | After the discharge port.                                  |
| Check valve         | To protect the pump from water hammer and to avoid the emptying of the discharge pipe after shutdown. | In the discharge line between the pump and the gate valve. |
| Gate valve          | To regulate the pump performance.   | After the check valve.                                     |
| Gate valve          | To exclude the air during the priming process.  | In the air vent piping.                                    |

TABLE 4.8.1: Recommended fittings in the piping.

 Carefully follow the manufacturer's use and installation instructions for all of the fittings.

**NOTE:** In order to reduce the pressure losses, the internal diameter of fittings and piping should be the same.

#### 4.9 CONTROL INSTRUMENTS

To guarantee correct operation the piping should be equipped with the below instruments:

| Recommended instrumentation |  |  |
|-----------------------------|--|--|
| Instrument                  | Use  | Location   |
| Minimum level probe         | To verify the reaching of the minimum level of liquid. | Into the suction tank.   |
| Vacuum gauge                | To verify the suction pressure in the suction pipe.    | Twice the diameter of the suction port far from the pump.                              |
| Thermometer                 | To check the temperature of the liquid.                | In the suction line.   |
| Thermometer                 | To check the temperature of the liquid.                | In the discharge line.   |
| Pressure gauge              | To measure the operating pressure.                     | Twice the diameter of the discharge port far from the pump and before the check valve. |
| Flow meter                  | To measure the operating flow.                         | After the gate valve in discharge line.  |
| Load monitor                | To prevent dry running.                                | Connected to the motor.  |
| Switch (ON/OFF)             | To start and stop the pump.                            | Control panel.   |
| Emergency switch            | To stop the operation of the pump in case of failure.  | Control panel.   |
| Wattmeter or Ampere-meter   | To monitor power absorption.                           | Control panel.   |

TABLE 4.9.1: Recommended control instruments in the piping.

 Carefully follow the manufacturer's use and installation instructions for all of the auxiliary control instruments.

#### 4.10 FINAL CHECK

1. Check that the bolts has been tightened correctly .
2. Check that the end caps have been removed from the suction and discharge flanges of the pump.
3. Check the parallelism between the flanges of the pipe and flanges of the pump.
4. Check the suction and discharge flanges has been tightened correctly.

#### 4.11 CONNECTION OF THE ELECTRIC MOTOR



**All electrical connections must be made by a qualified electrician in accordance with EN 60204-1. National or local regulations in force must be observed.**

**NOTE:**

An alarm system (visual or audio) must be fitted to warn the user in the event of a possible fault connected with the power supply or electric motor.



Avoid any electrical, hydraulic or mechanical overloading. Operations to be performed before starting the equipment:

- Check that the motor has been connected in compliance with the manufacturer's instructions.
- Check that the earthing connection complies with local regulations.
- Check the tag plate on the motor to ensure that the power supply is correct.
- Check the electric motor has been installed at room temperature, avoiding damp and dusty environments.
- Check the bottom part of the motor is sufficiently free, in proportion to the size of the motor to ensure free air circulation, essential for cooling.
- Install a switch (ON/OFF) and an emergency switch according to the regulation in force.
- Install a soft-start or inverter for motors larger than 11 kW.



If the pump is installed outdoor, waterproof the wiring to protect the electrical connections from rainwater.

Three phase motors can be connected "Star" or "Delta". Star connection is obtained by connecting together the terminals W2, U2, V2 and supplying the terminals U1, V1, W1. Delta connection is obtained by connecting the end of a phase with the beginning of the following one.

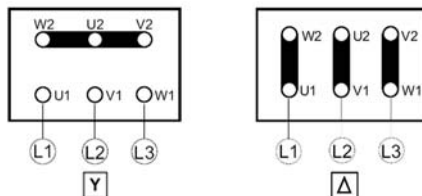

ILLUSTRATION 4.12.1: Electrical connections of the motor.

#### 4.12 CONNECTION OF THE INTERNAL COMBUSTION ENGINE

The user manual for the combustion engine is supplied with the pump. If the engine manual has not been provided, contact the manufacturer immediately. The user should read the instructions carefully and get to know the operations described. By not doing so he may place at risk his own health and safety and that of anyone else in the vicinity of the pump unit.



The responsibility to provide protections for the hot parts of the pump unit belong to the user.

**Some important instructions are given here below:**

- The fuel to be used is DIESEL. Never use other liquids or fuels.
- Before starting the engine check the level of the oil and the cooling liquid in the radiator.
- Check that the internal combustion engine rotates in the same direction as the pump.
- Every 350 working hours, check that the bolts for the pump are tight.

**Some important instructions related to safety are given here below:**

- The engine may be used or mounted on a pump unit only by personnel suitably trained in its operation and aware of the dangers involved. This is particularly true for standard and, above all, special maintenance work. For special maintenance contact personnel trained specifically by the manufacturer.
- The manufacturer declines all responsibility for accidents or for failure to comply with the requirements of law if changes are made to the engine's functional parameters or to the fuel flow rate adjustments and speed of rotation, if seals are removed, or if parts not described in the operating and maintenance manual are removed and reassembled by unauthorized personnel.
- Do not start the pump unit in closed or poorly ventilated environments. The internal combustion process generates carbon monoxide, an odourless and highly toxic gas, so spending too long a time in an environment where the engine discharges its exhaust products freely can lead to loss of consciousness and even death.
- The engine may not be used in environments containing flammable materials, explosive atmospheres or easily combustible powders.
- To prevent the risk of fire, keep the machine at a distance of at least one metre from buildings or other machines.
- Fuel is flammable, so the tank must be filled only when the engine is turned off. Dry carefully any fuel that may have spilled, remove the fuel container and any cloths soaked in fuel or oil, check that any sound-absorbing panels made of porous material are not soaked with fuel or oil, and make sure that the ground on which the machine is located has not absorbed fuel or oil.
- Before starting, remove any tools that have been used for carrying out maintenance work to the engine and/or the pump unit and check that any guards removed have been replaced. In cold climates it is possible to mix kerosene with the diesel fuel to make the engine easier to start. The liquids must be mixed in the tank by pouring in first the kerosene and then the diesel fuel. Consult the manufacturer technical office for mixture proportions. Petrol may not be used because of the risk of it forming flammable vapours.
- During operation the surface of the engine reaches temperatures that may be dangerous. Avoid in particular all contact with the exhaust system.
- Before carrying out any work on the engine, turn it off and allow it to cool down. Do not perform any operation while the engine is running.
- The liquid cooling circuit is under pressure. Do not carry out any checks before the engine has cooled down, and even then open the radiator cap or the expansion tank cautiously. Wear protective clothing and glasses. If there is an electric fan, do not approach the engine while it is still hot as the fan may come on even when the engine is not running. Clean the cooling system with the engine turned off.
- While cleaning the oil bath air filter, check that the oil is disposed of in such a way as not to harm the environment. Any filtering sponges in the oil bath air filter should not be soaked with oil. The cyclone pre-filter cup must not be filled with oil.
- Since the oil must be emptied out while the engine is still hot (approx. 80°C), particular care should be taken in order to avoid burns. In any case make sure that oil does not come into contact with your skin because of the health hazards involved.
- Check that the discharged oil, the oil filter and the oil contained in the oil filter are disposed of in such a way as not to harm the environment.
- Close the fuel tank filler cap carefully after each filling operation. Do not fill the tank right up to the top, but leave sufficient space to allow for any expansion of the fuel.
- Fuel vapours are highly toxic, so fill up only in the open air or in well ventilated environments.
- Do not smoke or use naked flames while filling.
- Take care when removing the oil filter as it may be hot.
- The operations of checking, filling up and replacing the cooling liquid must be carried out with the engine turned off and cold. Take particular care if liquids containing nitrites are mixed with others not containing these compounds as this may give rise to the formation of nitrosamines which are a health hazard. The cooling liquid is polluting, so dispose of in a manner that does not damage the environment.
- During operations which involve access to moving parts of the engine and/or removal of the rotary guards, disconnect and insulate the positive cable of the battery so as to prevent accidental short circuits and activation of the starter motor.
- Check the belt tension only when the engine is turned off.
- In order to move the engine simultaneously use the eyebolts fitted for this purpose by the manufacturer. These lifting points are however not suitable for the entire pump unit, so in this case use the eyebolts fitted by the manufacturer.
- To prevent accidental starting remove the ignition key of the engine after the shut-off of the pump.

 All of the safety instructions are contained in the engine user manual.

#### 4.12.1 Starting the engine

Insert the ignition key, turning it partially to the right until the LEDs switch on. When the yellow LED switches off, turn the key further to the right until the engine starts. Allow the engine to idle for at least 15 min, keeping the accelerator lever fully to the right then, very gradually, move the lever to the left until the required performance is reached and secure it there by tightening the knob on the control support. If the pump's flow rate and head values correspond to the engine's maximum rpm, secure the lever in position using the safety pin.

#### 4.12.2 Removing the engine's hood



To protect the health of the maintenance operator, the hood should only be removed when the engine is switched off and cold.

The removal procedure is as follows:













1. If there is an outside pipe connected to the end of the silencer, remove it.
2. Unhook the hooks on the side of the hood.
3. Attach slings to the ringbolt in the upper part of the hood.
4. Lift the hood vertically.



#### 4.13 EXAMPLES OF INSTALLATION

The following is a list of fittings, instruments or indications to be applied in the plant as shown in the examples on pages 15-17.

**NOTE:** The warning symbol  indicates the equipment and fittings needed for safety requirements.

| No. | Description   |
|-----|---|
| DN  | The diameter of the port of the pump.   |
| DN1 | The diameter of the pipe.   |
| A   | The minimum distance between the end of suction pipe and the bottom of the reservoir.   |
| B   | The minimum submergence of liquid of the suction pipe into the reservoir  |
| C   | The minimum distance between the pipes and the walls of the reservoir.  |
| E   | The minimum distance between the suction pipe and the filling pipe in the reservoir.  |
| 01  | SUCTION PIPE conveys liquid to the pump. In suction conditions, it should be as short and straight as possible and have an ascending gradient of 1% toward the pump while in flooded conditions it should have a descending gradient of 1% toward the pump. The flow velocity should not be higher than 2 m/s.                            |
| 02  |  BRACKET supports the piping preventing excessive loads on the branches of the pump. It should be built with or coated in material resistant to contact with the liquid and vapours.   |
| 03  |  DRAINAGE PIPE conveys the liquid evacuated from the pump to the reservoir. The end of the pipe should be open to the atmosphere. It is required a gate valve.   |
| 04  | BY-PASS ensures the pump's minimum flow rate is maintained. It conveys liquid to the reservoir or the suction piping.   |
| 05  | SUBMERGED TERMINAL is required for the suction pipe and filling pipe in the suction tank or reservoir to prevent the formation of vortices in the piping.   |
| 06  | WIDE RADIUS BEND has lower pressure losses compared with tight radius bends and prevents the formation of air pockets.  |
| 07  |  GATE VALVE isolates the pump from the piping.   |
| 08  | STRAINER reduces the concentration of solid particles in the liquid pumped.   |
| 09  | DRAINAGE PORT is the terminal of the pump that allows the drainage of liquid (provided on request).   |
| 10  | FOOT VALVE makes it possible to operate in suction conditions.  |
| 11  | ECCENTRIC REDUCER prevents the formation of air pockets.  |
| 12  | VACUUM GAUGE measures the suction pressure.   |
| 13  | SUCTION PORT is the terminal of the pump that allows entry of the liquid into the casing. It is connected to the suction piping.  |
| 14  | FILLING PORT is the terminal in the discharge piping that allows the liquid filling of the pump and suction piping.   |
| 15  | DISCHARGE PORT is the terminal of the pump that allows the exit of the liquid. It is connected to the discharge piping.   |
| 16  | DISCHARGE PIPE conveys the pumped liquid to a reservoir. The flow velocity should not be higher than 5 m/s.   |
| 17  | ECCENTRIC EXPANSION prevents the formation of air pockets.  |
| 18  | PRESSURE GAUGE allows to check the working pressure.  |
| 19  |  CHECK VALVE protects the pump from water hammer and avoids the emptying of the discharge pipe after shutdown.   |
| 20  | GATE VALVE permits to regulate the performance of the pump.   |
| 21  | FLOW METER allows to check the amount of liquid.  |
| 22  | FILLING PIPE conveys the liquid to the suction tank or reservoir.   |
| 23  |  REINFORCED CONCRETE BASEPLATE is required to guarantee stability to the pump.   |
| 24  |  SOLID GROUND is required to guarantee stability to the pump.  |
| 25  | EXTERNAL FLUSHING SYSTEM is used to flush or wash the mechanical seal with liquid from an external source.  |
| 26  |  LOAD MONITOR is used to prevent the dry running of the pump.  |
| 27  | BAFFLE WALL prevents air or vortices from entering in the suction pipe.   |
| 28  |  LEVEL PROBE is used to monitor the minimum level.   |
| 29  | PLUG FOR PROBE is used to apply an external level probe.  |
| 30  | SOLENOID VALVE is used for filling the self-priming tank.   |
| 31  | PLUG FOR PROBE is provided for the use of an internal level probe and monitoring the minimum and maximum levels in the tank.  |
| 32  | CFM PUMP transfers the liquid from a reservoir to another.  |
| 33  | SELF-PRIMING TANK permits to operate above the level of the liquid inside the suction reservoir.  |
| 34  | FLOW CONDITIONER minimizes swirl and turbulence in the suction piping.  |
| 35  | VENT, installed on highest point, allows the evacuation of the air or gas inside the piping or self-priming tank.   |
| 36  |  POWER SWITCH (ON/OFF) starts or stops the pump without activating or interrupting the other functions of the plant or other machinery.  |
| 37  |  EMERGENCY SWITCH, installed closed to the machinery, stops the operation of the pump in case of failure. It should be used ONLY if the discharge pipe includes a non-return device. It should be in accordance with the requirements of EN ISO 13850. |
| 38  |  WATTMETER/ AMPERE-METER monitors power absorption.  |
| 39  |  ALARM SYSTEM warns the user in case of fault of power supply or electric motor, absence of liquid in the suction piping or fault of auxiliary flushing.   |

#### GENERAL NOTES:

1. The sketches are illustrative. The recommendations refer to a general installation and some information may be missing.
2. All information shown are to be considered useful for the proper functioning of the pump and not for the plant.
3. Information contained in these sketches are deemed reliable. Affetti shall not be held responsible in the event that, despite their efforts to supply exhaustive and consistent information, the contents prove to be insufficient. The purchaser/user must check the information contained in this sketch.
4. Unless otherwise indicated the number of fittings (including brackets) and instruments and their position in the sketches are illustrative.

### 4.13.1 Installation in suction conditions

**NOTE:** The installation in suction conditions must be authorized by AFFETTI.

 Never increase the suction heights without the approval of AFFETTI. Maintain the same suction heights or lower than declared on the Order Confirmation or data sheet.

 Suction and discharge piping must be tested hydraulically in accordance with the safety regulations before installing the pump.

 The suction piping must be resistant to vacuum conditions.

 The emergency switch should be used **ONLY** if the discharge pipe includes a non-return device.

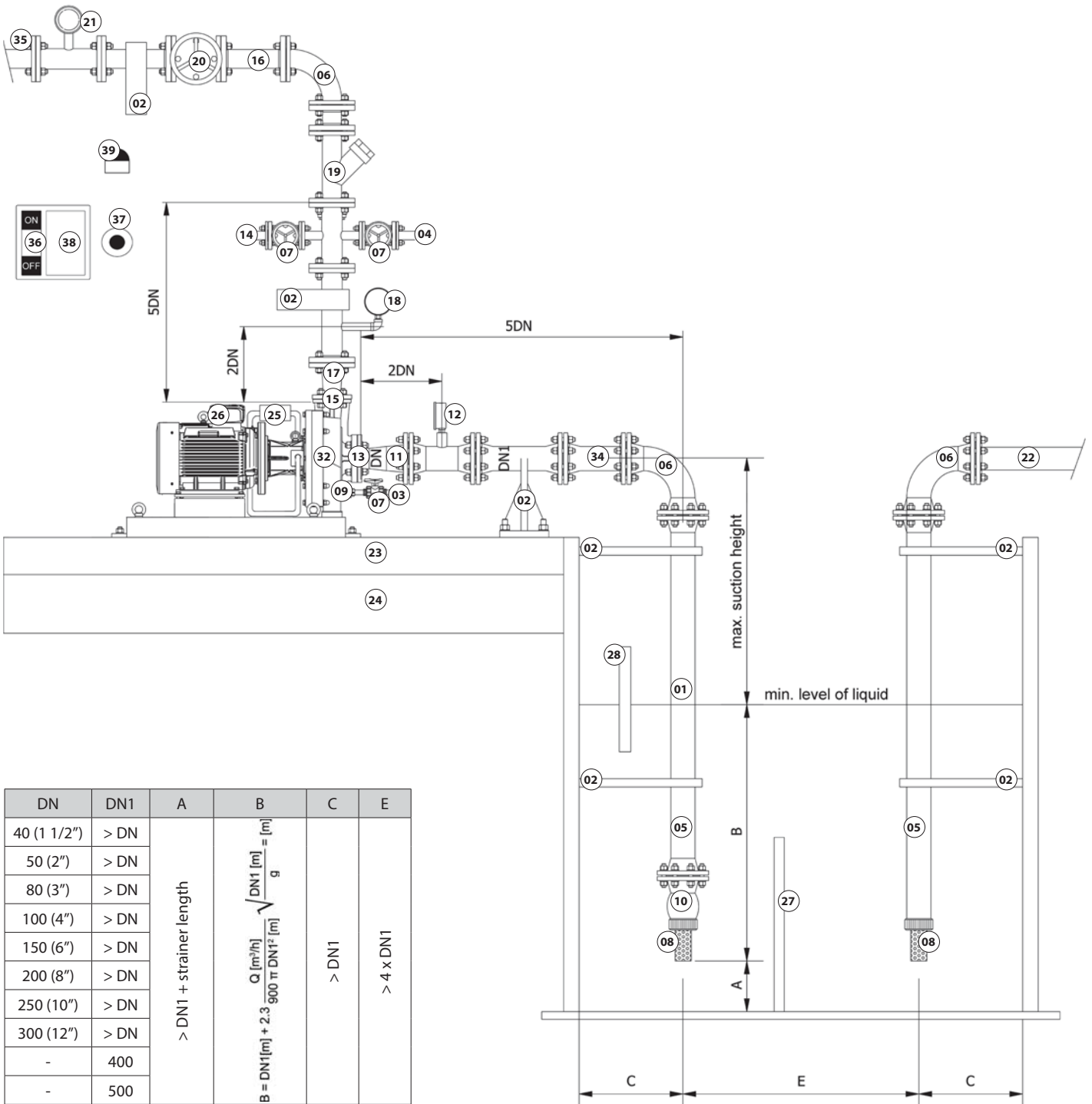

### 4.13.2 Installation in suction conditions with self priming tank.

**NOTE:** The installation of self-priming tank must be authorized by AFFETTI.

**NOTE:** It is recommended to use a common base for the pump and the self-priming tank.

**!** Never increase the suction heights without the approval of AFFETTI. Maintain the same suction heights or lower than declared on the Order Confirmation or data sheet.

**!** Suction and discharge piping must be tested hydraulically in accordance with the safety regulations before installing the pump.

**!** Never reduce the capacity of the self-priming tank.

**!** Fill the self-priming tank until reaching the maximum level of liquid before starting the pump.

**!** Monitor the minimum level of liquid in the self-priming tank during the operation.

**!** The solenoid valve should be connected to the probes inside self-priming tank and should be open when the liquid reaches the minimum level and closed when the self-priming tank is full (even during the operation).

**!** Check the vacuum pressure in the suction piping is not higher than vacuum resistance of the self-priming tank.

**!** The suction piping must be resistant to vacuum conditions.

**!** Forces and moments should not be applied to the suction pipe connected to the self priming tank. Use brackets.

**!** The emergency switch should be used ONLY if the discharge pipe includes a non-return device.

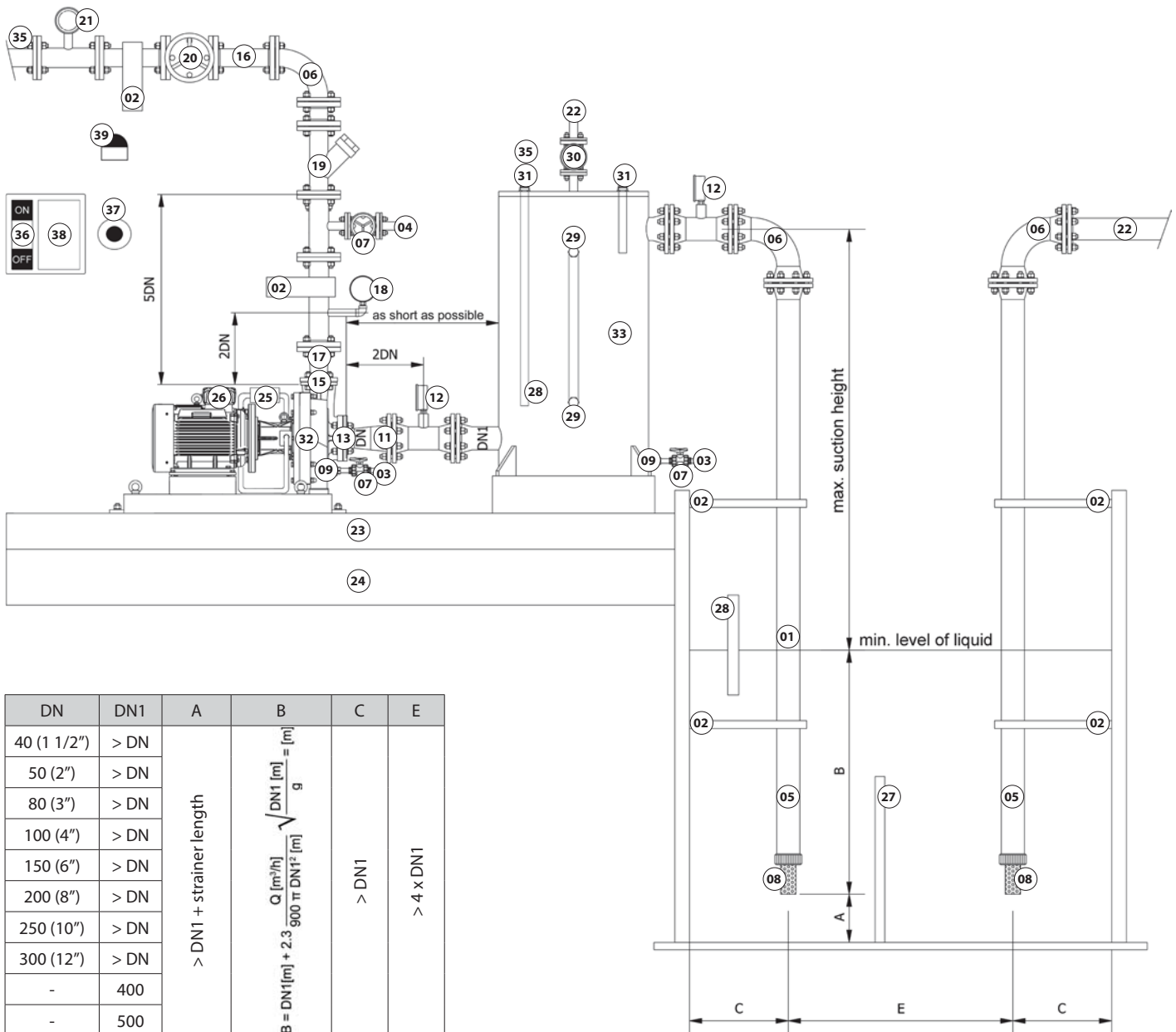

**4.13.3 Installation in flooded conditions.**

**!** Suction and discharge piping must be tested hydraulically in accordance with the safety regulations before installing the pump.

**NOTE:** The minimum distance between the pump and gate valve in the suction pipe should be not less than 5 times the diameter of the suction port.

**NOTE:** The minimum length of the straight suction pipe should be not less than 10 times the diameter of the suction port.

**!** The emergency switch should be used ONLY if the discharge pipe includes a non-return device.

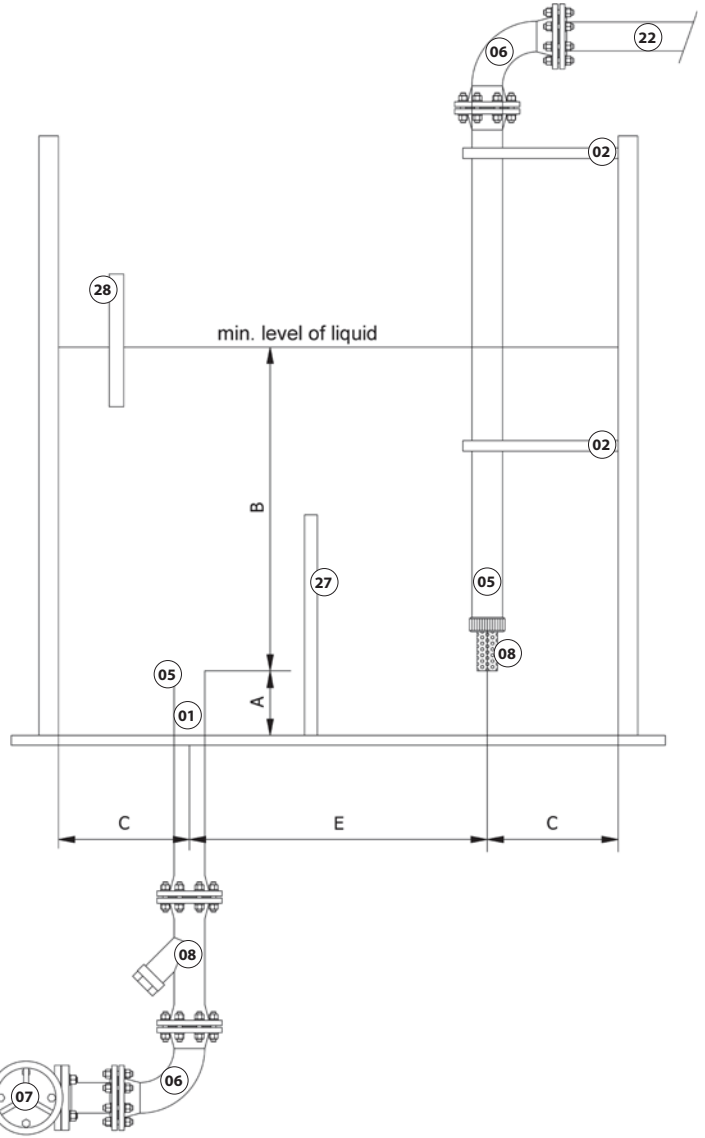
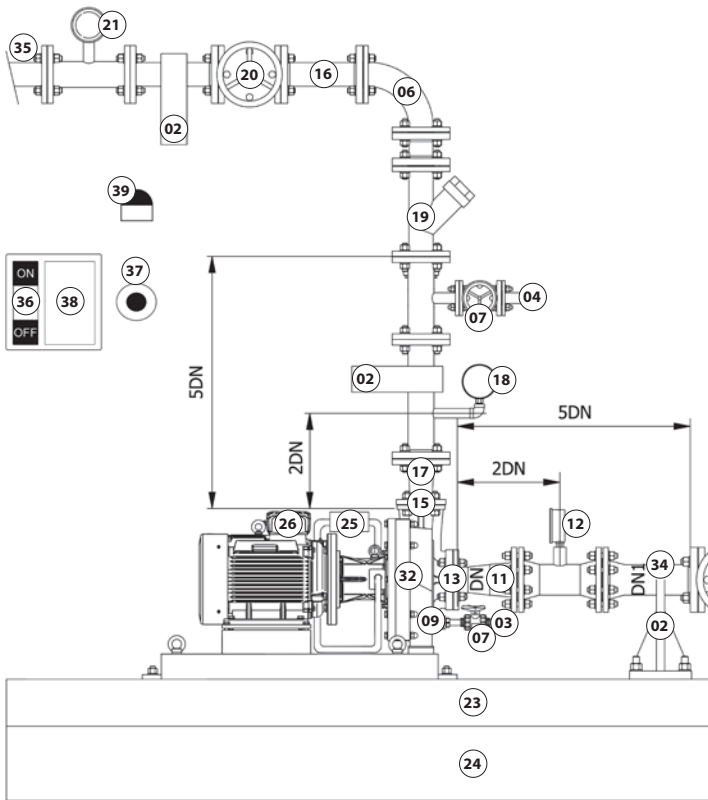

| DN          | DN1  | A                       | B  | C     | E         |
|-------------|------|-------------------------|--|-------|-----------|
| 40 (1 1/2") | > DN | > DN1 + strainer length | $B = DN1 [m] + 2.3 \frac{Q [m^3/h]}{900 \pi DN1^2 [m]} \sqrt{\frac{DN1 [m]}{g}}$ | > DN1 | > 4 x DN1 |
| 50 (2")     | > DN |                         |  |       |           |
| 80 (3")     | > DN |                         |  |       |           |
| 100 (4")    | > DN |                         |  |       |           |
| 150 (6")    | > DN |                         |  |       |           |
| 200 (8")    | > DN |                         |  |       |           |
| 250 (10")   | > DN |                         |  |       |           |
| 300 (12")   | > DN |                         |  |       |           |
| -           | 400  |                         |  |       |           |
| -           | 500  |                         |  |       |           |

## 5.0 OPERATION



The operators should be equipped with appropriate equipment during all operations of this chapter. Rubber boots, anti-acid overalls and a helmet with a protective visor for the face are essential requirements to allow operators to work without risking their physical safety. It is strictly prohibited to insert fingers or other parts of the body into the orifices and various openings. The pump unit is equipped with moving parts. The follow operations must be performed by skilled staff.

### 5.1 DIRECTION OF ROTATION

The direction of rotation should be checked before the start-up. The direction of rotation is indicated, in permanent form, on the pump unit; clockwise looking from the motor to the pump.



To ensure the correct direction of rotation is essential to use a phase-meter in order to identify the phases and the colours of the cables.



The pump should never run in the reverse direction of rotation.

#### NOTE:

The arrows indicating the direction of rotation should always be clean and visible.

### 5.2 PRELIMINARY PUMP TESTING

Before the start-up, manually rotate the pump shaft in the direction of rotation by the fan of the motor to make sure that it rotates freely and is free of friction or obstructions. The operation must be performed with electric cables disconnected from the terminal board.

### 5.3 FLUSHING

If a mechanical seal with external flushing is used, make sure the valve or tap is open before operating the pump and that the instructions given in the chapter 8 concerning quantity, pressure and compatibility of the flushing liquid are complied with.

#### NOTE:

The threaded connections of the external flushing should be in the same material of the threaded connections of the pump.

### 5.4 PRELIMINARY MOTOR TESTING

Check all of the electrical connections (see paragraph 4.11) and the direction of rotation (see paragraph 5.1) before the start-up of the pump.

### 5.5 START-UP

Before starting the pump the following steps should be performed:

1. Check the direction of rotation of the motor (refer to the arrow marked on the pump unit).
  2. Check that the suction and discharge pipes and gaskets are connected correctly and that all the bolts are well tightened.
  3. Close the drainage valves (if provided).
  4. Open the external mechanical seal flushing device (if provided). Quantities and operating pressure values related to flushing are specified in the chapter 8.
  5. Fully open the gate valve on the suction piping.
  6. Check and flush the suction piping to remove any solid or foreign bodies.
  7. In suction conditions fill the pump and the suction pipe completely and check that the foot valve is operating correctly.
  8. Turn the pump on using the power switch.
  9. Open gradually the gate valve in the discharge pipe (start from 10%).
  10. Adjust the duty point regulating gradually the gate valve (discharge pipe).
11. Check the absorption values of the pump unit referring to those marked on the tag plate of the motor and make sure that those values (absorbed power in kW or intensity in amperes) are not exceeded.

#### NOTE:

The pump must never run dry.

#### NOTE:

Clean the inside of the pump before the start-up procedure of a inactive or repaired unit.

#### NOTE:

Do not use the suction valve to adjust the flow. The suction valve must always be completely open.

#### NOTE:

Do not open excessively the discharge valve if it will cause the over-load of the motor. Open the discharge valve according to the duty point and amperage.

#### NOTE:

Alternate operation of the pump unit in use with the stand-by unit at weekly intervals.

### 5.6 OPERATION

Attention should be paid to the following warnings during the pump's operation:

- It is prohibited to work on the pump unit when it is in operation.
- It is prohibited to carry out any work on the motor when connected to the electric power supply.
- Prevent people or things coming into contact with hot parts of the pump unit.
- Make sure that the pump unit does not vibrate and is not excessively noisy (see paragraphs 5.10 - 5.11).



Check during the operation there are not increases in temperature.



The pump unit should never operate with one or some parts damaged. In the event of a fault, turn the pump off and investigate the cause (see paragraph 6.17).

#### NOTE:

The pump must never run dry.

#### NOTE:

During the operation check the discharge pressure do not exceed the allowable limit (see paragraph 2.3).

#### NOTE:

The pump should not operate more than 1 minute with the discharge valve fully closed.



Stop the pump in case of cavitation.

### 5.7 SHUTDOWN

Close the discharge valve (slowly to prevent water hammer) until reaching the 10% of the flow rate. Turn off the power switch and close completely the discharge valve. Later close the valve of the external flushing (if provided).



When the pump is stopped without a non-return device on the discharge pipe the liquid will flow through the pump to the suction source.

#### NOTE:

Start and stop the pump frequently will damage the pump early.

#### NOTE:

Do not use a solenoid valve to stop the pump unit.

#### NOTE:

When the ambient temperature falls below freezing point, the liquid tends to crystallize, or in case of storage the pump and the piping must be drained and washed after the shut-off of the pump.

#### NOTE:

Operation of the inactive pump should be checked on a regular basis.

#### NOTE:

If the pump remains inactive for a long period of time, rotate





the pump shaft (via the fan of the motor) at least 5 turns every week. See paragraph 3.4.

### 5.8 TEMPERATURES

The working temperature of the pump is indicated in the data sheet and in the order confirmation.

**NOTE:** The temperatures limits may vary changing the pumped liquid or its concentration. In order to know the temperature limit for the pumped liquid contact the manufacturer.

 If the operating temperature exceeds 60°C the pump must carry a warning notice to alert personnel working in the area.

 The personnel working close the pump unit must avoid any contact with the hot parts.

### 5.9 FLOW RANGE

The choice of the type of pump, impeller and motor is made at the time of offer based on data provided by the customer related to flow rate and head. The user should strictly observe the operating conditions mentioned on the data sheet, especially related to the data concerning flow rate, head and the liquid pumped for which the pump was intended. The pump should be used in accordance with the percentages shown in the paragraph 2.4. In the event that the operator needs to use the pump in a different point compared to that shown on the data sheet contact the manufacturer

### 5.10 VIBRATION LEVEL

Measurement of vibration performed at regular intervals, compared against the values provided by the manufacturer measured during the production test, will highlight any changes in the operating conditions, wear or imbalance of the rotating parts, installation conditions that do not meet the requirements for correct assembly of the pump to the plant or a general state of disrepair of the whole system.

| Working condition | Max. vibration level |               |               |
|-------------------|----------------------|---------------|---------------|
|                   | Motor ≤ 7,5 kW       | Motor ≤ 30 kW | Motor > 30 kW |
| Normal            | 3 mm/s               | 4,5 mm/s      | 6 mm/s        |

TABLE 5.10.1: Vibration level.

Note: the limits above are for new pump unit provided entirely by the manufacturers and carefully anchored in accordance with the instructions given in this manual. Used pump unit may have values of vibration exceeding the limits.

**NOTE:** The installation of anti-vibration mounts is recommended.

### 5.11 NOISE LEVEL

Generally the pump unit does not exceed the 80 dB. However, the noise level could increase due a sum of factors, as the duty point, size of motor, type and material of pipeworks and the structure of the building.

Approximate values are shown below:

| Motor nominal power [kW] | Noise level in dB(A) |          |          |          |
|--------------------------|----------------------|----------|----------|----------|
|                          | 1480 RPM             | 1780 RPM | 2950 RPM | 3500 RPM |
| 1.5                      | 58                   | 59       | 63       | 64       |
| 2.2                      | 60                   | 61       | 66       | 67       |
| 3                        | 62                   | 63       | 68       | 69       |
| 4                        | 63                   | 64       | 69       | 70       |
| 5.5                      | 65                   | 66       | 71       | 72       |
| 7.5                      | 66                   | 67       | 72       | 73       |
| 11                       | 68                   | 69       | 74       | 75       |
| 15                       | 69                   | 70       | 75       | 76       |

|      |    |      |      |      |
|------|----|------|------|------|
| 18.5 | 70 | 70.5 | 76   | 77   |
| 22   | 71 | 72   | 77   | 78   |
| 30   | 72 | 73   | 78   | 79   |
| 37   | 73 | 74   | 79   | 80   |
| 45   | 74 | 75   | 80   | 81   |
| 55   | 75 | 76   | 80.5 | 81.5 |
| 75   | 79 | 77   | 81   | 82   |
| 90   | 76 | 77.5 | 82   | 83   |
| 110  | 77 | 78   | 82.5 | 83.5 |
| 160  | 79 | 80   | 84   | 85   |
| 200  | 80 | 81   | 85   | 86   |

TABLE 5.11.1: Pump unit's sound pressure.

NOTE: The noise values were measured during operation of the pump driven by an electric motor, pumping water at ambient temperature, cavitation free, at the best efficiency point in our test room. Operational factors such as the flow rate, type of pipework and acoustics of the building can increase the pump's sound pressure. The values specified are therefore subject to a tolerance of +5 dBA and are not guaranteed.

 Acoustic emissions should be lower than the maximum levels permitted by local regulations. If the noise level exceeds the safety values, some action that can be taken to protect the health of personnel exposed to sound pressure generated by the pump are indicated here below:

| Sound pressure     | Action to be taken   |
|--------------------|--|
| Less than 70 dB    | No particular action   |
| Greater than 70 dB | Provide personnel working close to the pump with personal protective equipment.  |
| Greater than 80 dB | Signs must be put up at the entrance to and within the area warning that it is a hazardous area due to the high sound pressure level. Anti-noise head phones must be worn. The pump unit must be equipped with a soundproof covering. Anti-noise head phones must be worn. |

TABLE 5.11.2: Actions to protect the health of the personnel.

 If the pump is driven by an internal combustion engine the noise level may exceed 80 dB. If this is the case, the pump unit should be provided with a soundproof covering and personnel must use PPE to protect them from the noise.

 **CAUTION** Excessive noise from the motor could be a sign that the bearings are worn and excessive noise from the pump could be a sign of cavitation (cavitation typically produces a booming sound, as if the liquid being pumped contains gravel).

## 6.0 MAINTENANCE

 **CAUTION** The operators should be equipped with appropriate equipment during all operations of maintenance. Rubber boots, anti-acid overalls and a helmet with a protective visor for the face are essential requirements to allow operators to work without risking their physical safety. It is strictly prohibited to insert fingers or other parts of the body into the orifices and various openings. The pump unit is equipped with moving parts. These operations must be performed by skilled staff.

### 6.1 PREVENTIVE MAINTENANCE

Check the characteristics of the pumped liquid (temperature, specific gravity and chemical composition). Check that the flow rate and pressure values comply with the design values and that they have not been subject to change. Make sure that control instruments are fully efficient and they always receives the right signals.

## 6.2 MAINTENANCE INSTRUCTION

Some instructions for the safety of personnel performing maintenance on the pump unit are given here below:

 Before carry out any maintenance work should be analysed the safety data sheet of the pumped liquid.

 All maintenance operations should be carried out outside of hazardous areas previously allocated for this purpose.

 For loads greater than the manual handling (including spare parts) use a suitable, type-tested hoisting system that is in good condition connected to rings, eyebolts, holes or threaded terminals of the part to lift. Goods must only be handled by suitably trained personnel, according to the relevant regulations in force.

 If the lighting is not sufficient the inspection and all maintenance operations should be performed using portable lamps.

 Any work must be carried out when the pump is not operating. If a switch has been fitted, it must be set to the "zero" (off) position.

 Take precautions to ensure that the pump is not started involuntarily.

 Never touch the pump if the liquid pumped exceeds +70°C. Wait until the pump cools down before performing any work.

 If the liquid pumped is hazardous take appropriate safety precautions when performing maintenance work, in accordance with the regulations in force.

 Never spray water or washing liquid on hot parts or components as it could cause thermal shocks.

 **DANGER** If the pump is washed using a high-pressure water jet, prevent sprays or drops of liquid from entering the terminal board of the electric motor.

**NOTE:** Replace gaskets and O-rings each time the pump is disassembled.

**NOTE:** On completion of any maintenance work, for the start-up procedure repeat the steps indicated in the paragraph 5.5.

## 6.3 DAILY INSPECTION AND MAINTENANCE

Daily monitoring during operation will avoid complications and ensure immediate action can be taken in the event of malfunction.

Inspect the pump unit every time it is used:

1. Check the noise level, vibration, temperature and performance.
2. Check that there are no unexpected leakages of liquid.
3. Make sure that the external flushing pressure for the mechanical seal is at least 1 bar greater than the operating pressure.
4. Make sure the pump never operates without liquid.
5. Check the drip-pan of baseplate (if provided) is not full of liquid. In this case, open the valve and empty the drip-pan.
6. Always make sure that the pump unit is properly fastened, checking that all of the screws are tightened correctly.

## 6.4 SIX-MONTHLY INSPECTION AND MAINTENANCE

Inspect the pump every six months irrespective of whether it has been used or not.

The six-monthly maintenance procedure is as follows:

1. Disconnect the electrical part.

2. Drain the casing of the pump (if the drainage hole is provided).
3. Clean and wash the pump, checking the compatibility of cleaning products used with residues of the liquid pumped. Never use flammable solvents to clean the parts.
4. Disassembly the pump unit (see paragraph 6.14).
5. Check the condition of the mechanical seal.
6. Check if the plastic parts are damaged or worn.
7. Check if there are cavitation traces.
8. Replace gaskets and O-rings.
9. If the liquid contains solid particles, check that the suction filter and the foot valve (in suction conditions) are clean.
10. Check the condition of the bolts used to fasten the baseplate and foundation (see paragraph 4.2).
11. Assembly the pump unit (see paragraph 6.15).
12. Make sure that the pump is properly fastened, checking that all of the screws are tightened correctly.
13. Start-up the pump (see paragraph 5.5).

If a fault is found replace the damaged or worn parts or according to the manufacturer send back the pump to repair (see paragraph 6.13).

 If the pump is used on fluids with solids particles or high temperature may be requested an earlier inspection and maintenance work.

## 6.5 EXTRAORDINARY MAINTENANCE

Immediate action must be taken in the event that a fault, malfunction or fluid leakage is reported by the operator or signalled by the general electrical panel, stopping the pump according to the shutdown procedure (see paragraph 5.7). The cause of the fault or malfunction must then be analysed, see paragraph 6.17. It is important to contact the manufacturer if the source or cause of the problem cannot be identified. No work must be carried out on the pump without prior approval from the manufacturer.

 In case of emergency or safety risk for the personnel can be used the emergency switch if a non-return device is included in the discharge piping.

 In the event of leakages of corrosive or hot liquid immediate actions to avoid the any contact, such as the evacuation of the area, must be taken. The corrosive liquid must be removed by authorized companies in accordance with national laws and regulations.

## 6.6 CRYSTALLIZATION OF PUMPED LIQUID

The crystallization of liquids is a problem that should not be underestimated. The user must obtain the technical data sheet of the pumped liquid from the relevant supplier to identify at what temperature and under what circumstances the crystallization process begins. The manufacturer must be informed of the use of any liquid that has a tendency to crystallise. Failure to declare the required information will invalidate the AFFETTI warranty.

## 6.7 DRAINING AND CHANGING THE PUMPED LIQUID

The user must request written consent from the manufacturer for any variation in the liquid to be pumped. Different specific gravity or viscosity could affect the suction lift or increase the shaft power and the discharge pressure.

The procedure to be followed when changing the liquid to be pumped is as follows:

1. Stop the pump unit (see paragraph 5.7).
2. Drain completely the pump (if drainage hole is provided) and the suction piping.
3. Clean the pump internally with water or a compatible liquid, taking care with regard to any chemical reactions that could cause irreparable damage to the pump and the operator.
4. Dispose of the rinsing liquid, with due care for the protection of the environment.

 In the event of leakages of corrosive or hot liquid immediate actions to avoid the any contact, such as the evacuation of the area, must be taken. The corrosive liquid must be removed by authorized companies in accordance with national laws and regulations.

 In case of leakage of not corrosive liquid provide immediate cleaning of the parts and the floor according to the safety recommendations.

### 6.8 DRY RUN OPERATION

The pumps of this series should never dry run. The dry run operation could damage the mechanical seal or the other parts of the pump. Below are listed situations in which dry run operation could occur:

- Total or partial absence of fluid in the tank.
- Missing or malfunction of the instrumentation to verify the absence of liquid in the piping or in the tank.
- Inefficient maintenance of the filter or foot valve
- Failing of the gate valve in the suction piping.
- The formation of air pockets and cavitation due to incorrect sizing and an inadequate structure of the fittings in the suction piping.

### 6.9 IMPURITIES CONTAINED IN THE PUMPED LIQUID

The pumped liquid should be clean. It is advisable not pumping liquids with percentages, even low, of solid particles. In case the liquid contains solids particles, the concentration, size and hardness must be declared in the enquiry in order to allow selection of the most suitable solution for the application.

**NOTE:** Solid particles in the liquid increase the wearing of the internal parts.

**NOTE:** If the liquid contains solid particles, install a strainer in the suction pipe.

**NOTE:** If solid particles are being pumped, it is recommended to have mechanical seal faces in Silicon Carbide.

**NOTE:** Slurry liquid pumping is not possible.

### 6.10 RECOMMENDED SPARE PARTS

To determine the minimum quantity of spare parts that should be kept available for any replacements that may be required, the user should take into consideration the operating conditions and the number of interchangeable units installed on the plant. In order to know the frequency of replacement for each unit please contact AFFETTI technical department.

The spare parts listed below are always needed on stock for each unit in operation:

| No.  | Description         | No.    | Description        |
|--|---------------------|--------|--------------------|
| 2  | Impeller            |        |                    |
| 2B, 33B, 35B, 47, 49, 73, 89D (1N, 17A optionally) | O-rings and gaskets | 17     | Gland (optionally) |
| 6  | Shaft               | 24     | Impeller nut       |
| 14   | Shaft sleeve        | 80, 89 | Mech. seal         |

TABLE 6.10.1: Recommended spare parts.

**NOTE:** Replace gaskets and O-rings each time the pump is disassembled.

To order spare parts you must provide:

- The serial number, name and type of pump (marked on the tag plate).
- Component position number (see on pages 28 - 36).
- Number of pieces required.

**NOTE:** Spare parts must be manufactured exclusively by AFFETTI. The use of parts not manufactured by AFFETTI will invalidate the pump's warranty and safety certification.

**NOTE:** Spare parts must be kept in a dry, clean place, away from sources of vibration and at a temperature of between +5°C and +35°C.

### 6.11 MINOR CRACKING AND HOLES REPAIRING FOR FRP MATERIAL

For superficial cracking (not structural) it is possible to make an easy and quick repair.

1. Check properly where the cracking is and the depth of it;

2. The part to be repaired need to be de-rusted, clean, dry, fat-free and sanded.
3. Use a filler, vinyl ester (for external and internal parts) or polyester (only for external parts) easily available in the market. The filler need to be suitable for fiberglass.
4. Take the requested portion of putty compound out of the can and mix it well with the corresponding quantity of hardener.

**Normal addition of hardener (please check with the filler used):**  
A-Component (Basis) : B-Component (Hardener) = 2 : 1 weight parts

5. Apply the mixed material in the layer thickness. Be sure that the complete empty space is fully filled.
6. Wait for the dry of the filler (check the time needed by the different supplier)
7. Sand and paint the part if needed (with epoxidic paint or gelcoat).

 For any treatment or working on the fiberglass parts the operator must use PPE, such as dust mask, dust mask respirator and protective visor to avoid inhalation of dust produced or contact of skin or face with the harmful or irritating substances.

### 6.12 DISPOSAL

Replaced parts or pump units that have reached the end of their working life must be subjected to a careful selection process to separate and dispose the various parts according to their material.

 Disposal of used or damaged pumps must be done in accordance with laws and regulations by specialized and authorized companies.

### 6.13 RETURNING OF THE PUMP UNIT

Before returning the pump unit to repair in the manufacturer's factory the pump must be drained completely and cleaned internally with water or a compatible liquid, taking care with regard to any chemical reactions. Rinsing liquid should be disposed according national laws and local regulations.

 In case the pump is returned with the liquid inside or not completely drained and washed AFFETTI will send back the goods with transport on charge of the user.

### 6.14 DISASSEMBLY OF THE PUMP UNIT

 **Do not try to disassemble or repair the pump unit by your-self. Disassembly procedure of the pump unit should only be performed by personnel in possession of at least basic mechanical knowledge and skills. Minimum knowledge of the materials used is also needed to provide a better understanding of the pump's characteristics.**

 Never try to remodel the pump or change some parts without the authorization from the manufacturer.

Before disconnecting the pump from the plant follow the below procedure:

- Make sure that the pump unit is not in operation.
- In order to avoid any unexpected start-up during the maintenance working disconnect the plug from the electric board and the electric wires from the terminal board of the motor. Carefully isolate the ends.
- Close the suction and discharge valves.
- Wait until the pump unit reaches the ambient temperature.
- Open the draining valve and clean the wetted parts and the drip-pan of the baseplate (if provided) with water or an appropriate liquid and dispose the pump washing solution according to laws and regulations.
- Disconnect the pump unit from the system.

**NOTE:** Great care must be taken during the disassembly process to prevent damage to internal parts of the pump caused by the incorrect use of pliers and screwdrivers.

**NOTE:** Place the various components on a bench in the same order in which they are removed and protect them from knocks and dust.



## DISASSEMBLY PROCEDURE

**NOTE:** Identify all of the parts and their codes on pages 28 to 36 before proceeding with disassembly.

**!** If provided, pay attention during the disassembly procedure of the drainage and the drip pan of the baseplate. If traces or small quantity of liquid are into the drip pan remove it with care avoiding any leakage of liquid.

**CAUTION** Damaged or deteriorated tools are dangerous. Use qualified and suitable tools only.

**NOTE:** Single disassembly operations should be performed only if necessary.

1. Arrange all of the required tools on a bench:
  - A. Key for internal hexagon socket screws
  - B. Curved-nose pliers for internal elastic ring
  - C. Hexagon key
  - D. T-handle key for external hexagon socket screws
  - E. Rubber mallet
  - F. Impeller extractor
  - G. Belt wrench
  - H. Socket spanner

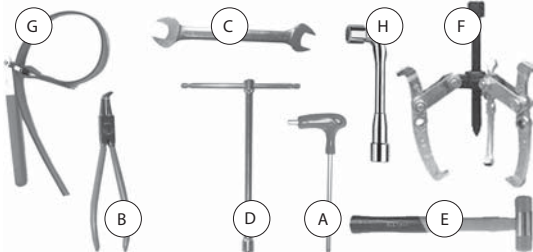

2. Unscrew the fixing screws of the pump (Pos. 1Q, 1R) and the motor (Pos. 300A, 300B). Remove pump and motor from the baseplate.

3. Unscrew (right thread) the casing fastening nuts (Pos. 1C, 1D).

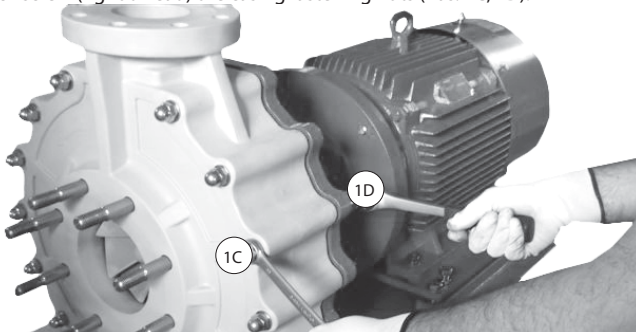

4. Extract the pump casing (Pos. 1) tightening the screws (Pos. 67) on the frame adaptor (Pos. 71G) in a crosswise fashion.

5. Unscrew (right thread) the impeller nut (Pos. 24) using a socket spanner (H), tightening the impeller (Pos. 2) with a belt wrench (G).

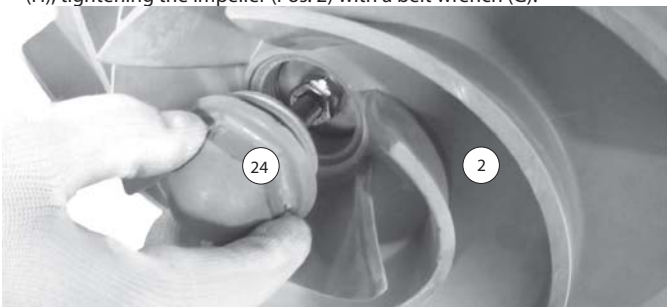

6. Operation only for pumps belonging to groups 2 and 3: unscrew the 2 slim nuts (Pos. 24A). Groups listed in table 2.1.6.1.



7. Remove the impeller (Pos. 2) from the shaft (Pos. 6) using an extractor (F).

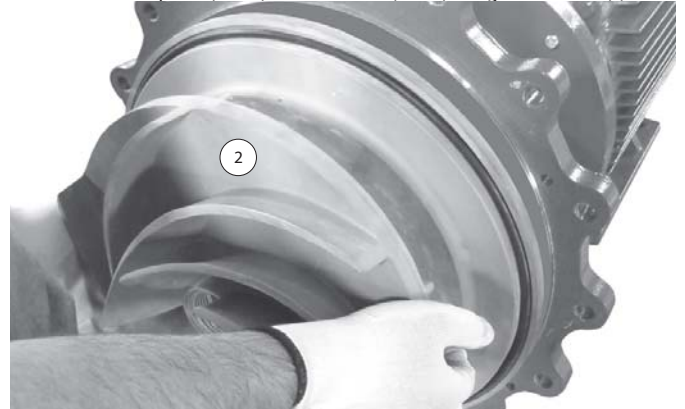

8. Remove the cover (Pos. 11).

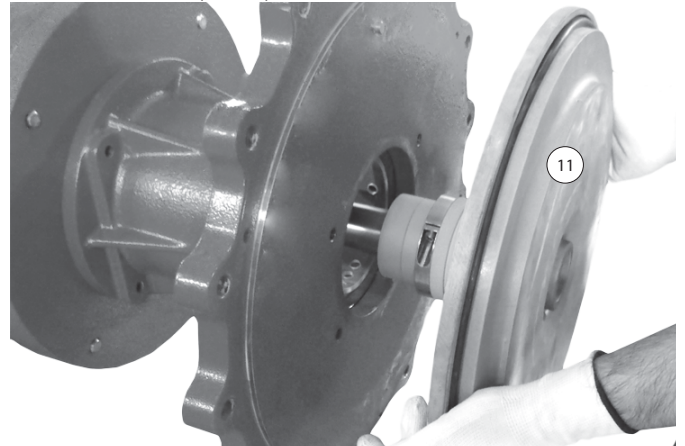

9. Disassembly the mechanical seal group. For detailed information contact the manufacturer.



10. Remove the external protection (Pos. 17B).



11. Unscrew the fasteners (Pos. 71C).

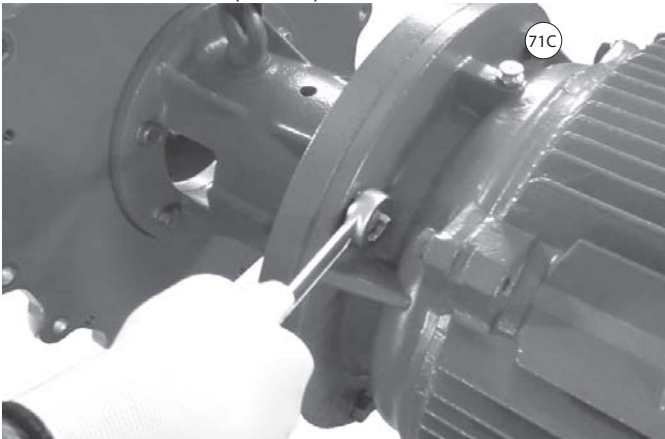

12. Disassembly the frame (Pos. 71) and the frame adaptors (Pos. 71B, 71G).

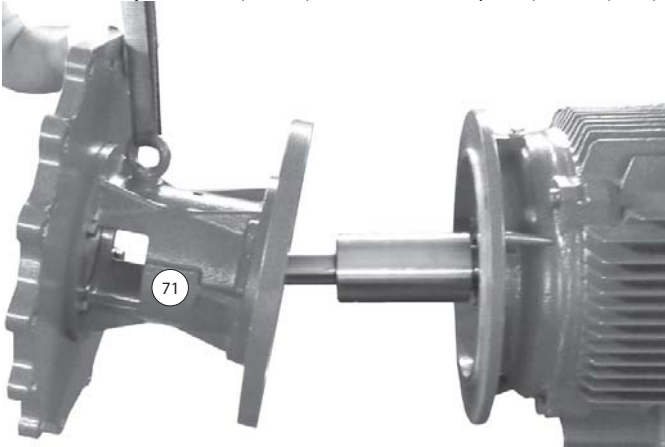

13. Unscrew the socket set screws (Pos. 6A) on the shaft (Pos. 6).



14. Remove the pump shaft (Pos. 6).



### 6.15 ASSEMBLY OF THE PUMP UNIT

**!** These operations must be carried out by qualified technical personnel.

**!** Any work must be carried out when the pump unit is not operating. If a switch has been fitted, it must be set to the "off" position.

**!** Take precautions to ensure that the pump unit is not started involuntarily, disconnecting the cables from the power supply.

**NOTE:** Considerable precision and care must be taken when performing the operations involved in the assembly procedure.

**NOTE:** Thoroughly clean any parts still in good condition using water or an appropriate solvent before assembling a pump in repair.

**NOTE:** The assembly procedure should be carried out in a place free of dust and vibrations.

The tightening torques (N/m) for the pump assemblies are indicated here below:

| POS. | Description                  | Group I                           | Group II            | Group III |
|------|------------------------------|-----------------------------------|---------------------|-----------|
| 1C   | Casing/adaptor closure       | 20*                               | 31-45               | 65        |
| 1M   | Drainage plate screw         | 4                                 | 4                   | 4         |
| 1Q   | Casing/baseplate fixing      | 20                                | 20-30               | 60        |
| 6A   | Grub screw shaft             | 4                                 | 4                   | 4         |
| 17C  | Gland fixing                 | 7                                 | 7                   | 10        |
| 24   | Impeller nut fixing          | Manual fixing with socket spanner |                     |           |
| 24A  | Slim nut fixing              | -                                 | T-handle key fixing |           |
| 71C  | Frame/cast iron motor fixing | 10-26                             | 14-40               | 26-40     |
| 71E  | Adaptor/frame fixing         | 15                                | 15                  | 15        |

TABLE 6.15.1: Tightening torques in N/m.

NOTE: The tightening torques for casing/adaptor closure of CFM 1.5x1x6 and 1.5x1x8 is 15 N/m.

| Flange DN | Torque (N/m) | Flange DN     | Torque (N/m) |
|-----------|--------------|---------------|--------------|
| 1,5"      | 12-16        | 4"            | 37-49        |
| 2"        | 24-33        | 6" or greater | 47-68        |
| 3"        | 31-41        |               |              |

TABLE 6.15.2: Tightening torques for flanges in N/m.

| IEC motor frame | Torque (N/m) | Motor frame | Torque (N/m) |
|-----------------|--------------|-------------|--------------|
| 80 - 90         | 6            | 200 - 225   | 26           |
| 100 - 132       | 10           | 250 - 280   | 40           |
| 160 - 180       | 14           | 315         | 57           |

TABLE 6.15.3: Tightening torques in N/m for fixing cast iron motor to baseplate.

**NOTE:** Apply an equal torque to each bolt tightening in diagonal order.



### ASSEMBLY PROCEDURE

**!** All steps of the assembly procedure must be performed to make the pump unit complies with 2006/42/EC Machinery Directive.

**NOTE:** Identify all of the parts and their codes on pages 28 to 36 before proceeding with assembly.

**!** **CAUTION** Damaged or deteriorated tools are dangerous. Use qualified and suitable tools only

1. Arrange all of the assembly tools on a bench:
  - A. Key for internal hexagon socket screws
  - B. Straight-nose pliers for internal elastic ring
  - C. Hexagon key
  - D. T-handle key for external hexagon socket screws
  - E. Rubber mallet
  - F. Dynamometric wrench
  - G. Belt wrench
  - H. Socket spanner

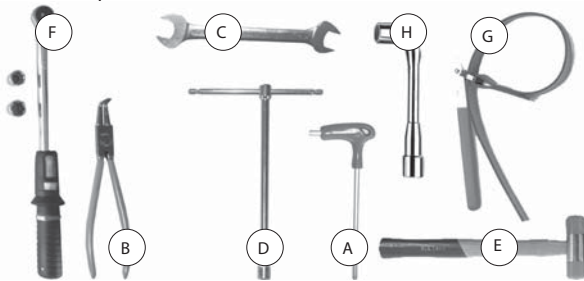

2. Place the motor (Pos. 300) on the base plate (Pos. 301)
3. Insert the pump shaft (Pos. 6) on the motor (Pos. 300).



4. Fix the pump shaft (Pos. 6) by the socket set screws (Pos. 6A). Use a key for internal hexagon (Pos. A). Apply threadlocker on the screws (Pos. 6A)



5. Verify the concentricity of the pump shaft (pos. 6) by a comparator during the manual rotation. The shaft runout should not exceed 0,05 mm. Adjust the shaft runout by a rubber mallet (Pos. E).

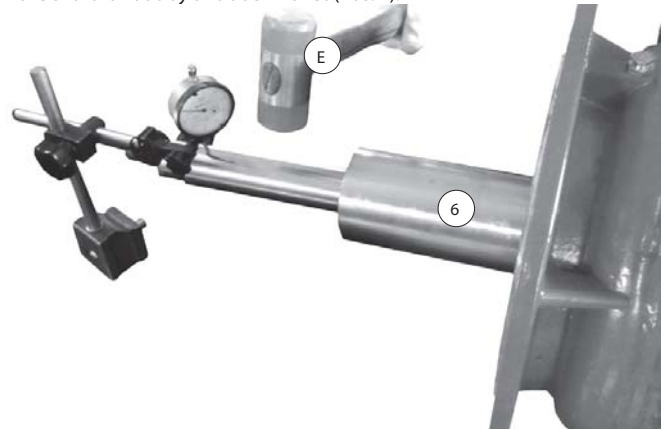

6. Fix the frame adaptors (Pos. 71B, 71G) to the frame (Pos. 71)
7. Place the frame (Pos. 71) and the frame adaptors (Pos. 71B, 71G).

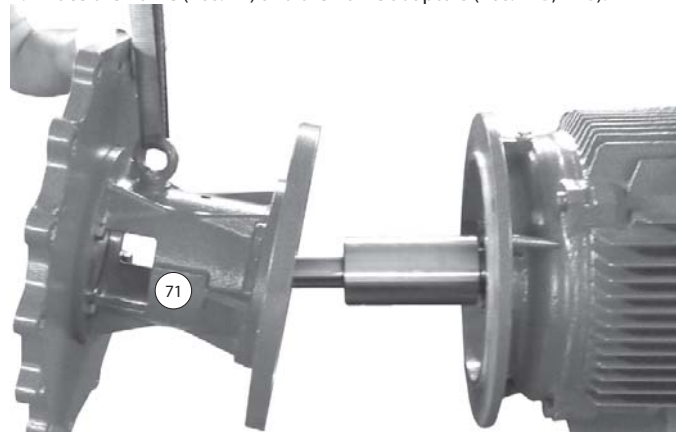

8. Fix the frame adaptor (Pos. 71) by fasteners (Pos. 71C).

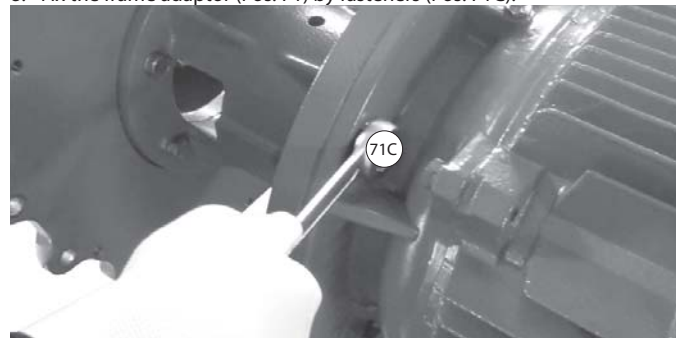

9. Place the external protection (Pos. 17B) with the holes facing downwards.

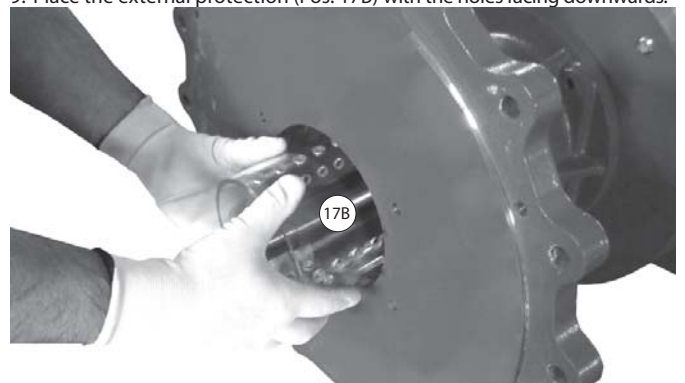

10. Assemble the mechanical seal group. The working lengths of mechanical seals are indicated on pages 35-39. Detailed assembly procedure can be requested to the manufacturer.

11. Fix the mechanical seal group to the cover (Pos. 11). Below picture is referred to JRS / JRS1 mechanical seal only.



12. Place the O-ring (Pos. 73) on the cover (Pos. 11)

13. Assemble the cover (Pos. 11) so that the internal flushing hole points upwards.

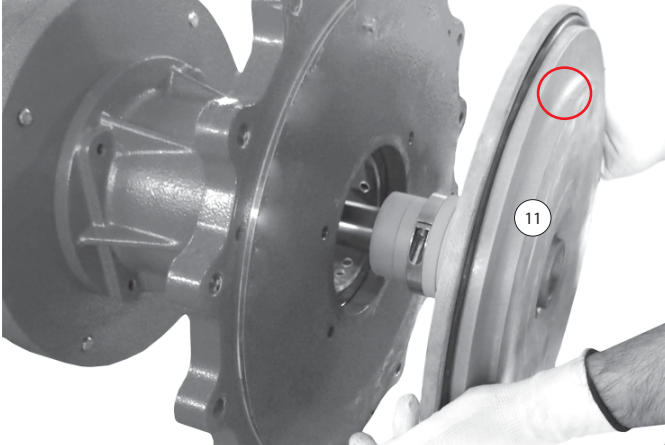

14. Only for groups II and III: lock the shaft sleeve into position using the key (Pos. 14A).

15. Only for groups II and III: insert the key (Pos. 6B) inside the front housing of the shaft, on the impeller side (Pos. 6).

16. Insert the cap or O-Ring (Pos. 2B) into its site on the rear part of the impeller (Pos. 2).

17. Place the impeller (Pos. 2) on the shaft (Pos. 6).

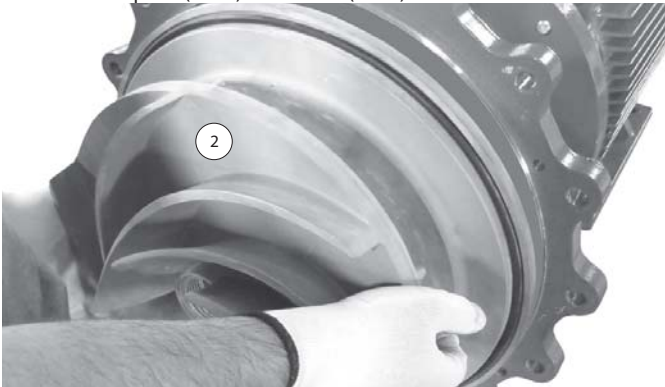

18. Only for groups II and III: insert the impeller washer (Pos. 24B) and fasten the two nuts (Pos. 24A) to the shaft (Pos. 6) using a T-handled key for external hexagon socket screws (D) and a belt wrench (G) to hold the impeller (Pos. 2) in place.

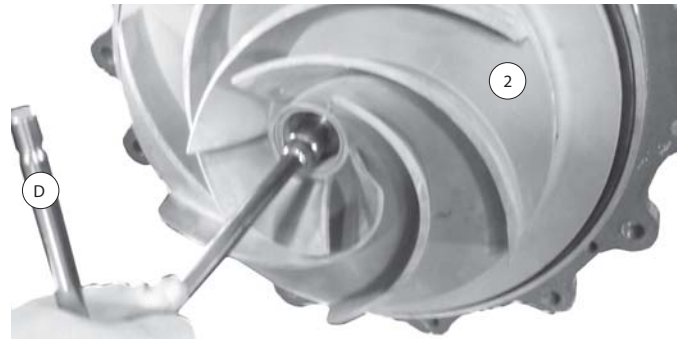

19. Insert the O-Ring (Pos. 24C) into its site on the impeller nut (Pos. 24).

20. Fasten the impeller nut using a socket spanner (H) and belt wrench (G).

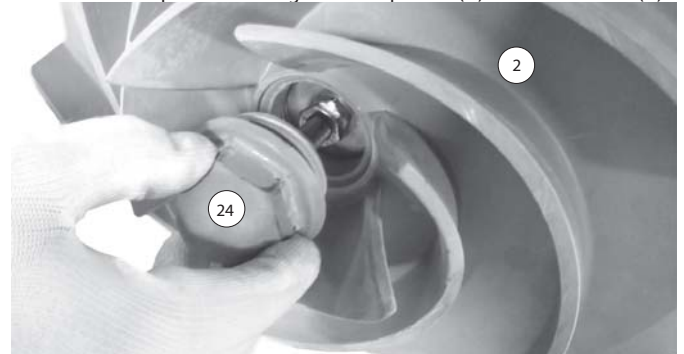

21. Insert the pump casing (Pos. 1) so that it slots into place on the cover (Pos. 11) by the cylindrical pin (Pos. 11A).

22. Use a dynamometric wrench to fasten the closure bolts (see table 6.15.1).

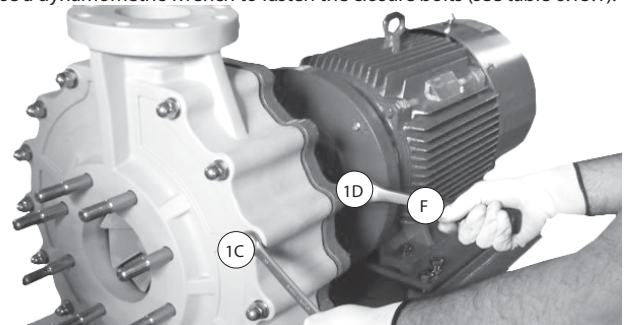

 In case of tapped holes on the suction or discharge flanges do not tighten the studs over the extension of the thread. Always check the depth of the tapped holes before tightening the studs.

23. Check the alignment according to the paragraph 6.16 and fix the pump unit to the base plate.

#### 6.16 PUMP-MOTOR AXIS ALIGNMENT

The CFM pump baseplate has, on request, an adjustment system to align the pump unit axis.

The procedure for aligning the motor is as follows:

1. Position the motor (Pos. 300) onto the baseplate (Pos. 301), adjust its position by the spacing screws (Pos. 300C) and tighten the fixing the fasteners (Pos. 300A, 300B).
2. Adjust the motor axis to the required height by screwing or unscrewing the screws in a crosswise fashion (Pos. 23A, 23B, 23C).
3. Check the alignment of the pump unit by observing the planar position of the casing (Pos. 1) upon the baseplate (Pos. 300).



**6.17 CAUSES OF TROUBLE AND TROUBLESHOOTING**

| TROUBLE  | CAUSES   | TROUBLESHOOTING  |
|--|--|--|
| THE PUMP DOES NOT PUMPING OR IN SUCTION CONDITIONS THE PRIMING IS SLOW | Insufficient NPSHa   | Check NSPHa is greater then NSPHr + 1 meter.   |
|  | The end of the suction pipe or the foot valve are not submerged.   | Submerge the end of the pipe or the foot valve at the recommended distance.                                    |
|  | In suction conditions the foot valve is too small or faulty.   | Check or replace the foot valve.   |
|  | In suction conditions the suction lift exceed the pump ability.  | Check the suction height is not higher than the pump limit or the level of liquid is the tank is not too low.  |
|  | The suction pipe is too long or the diameter is too small.   | Check the dimension of the suction pipe.   |
|  | Air leaks in the suction piping.   | Check the sealing condition and tightening between the connections on the suction piping.                      |
|  | The gate valve in the suction pipe is closed or partially closed.  | Open the gate valve completely.  |
|  | The specific gravity, temperature or viscosity of the liquid are higher then design values.                      | Check the specific gravity, temperature and viscosity values.  |
|  | Foreign bodies obstruct the impeller or the suction or discharge piping.   | Remove the foreign bodies.   |
|  | The impeller is worn or damaged or the distance between the impeller and the casing is greater than recommended. | Close the impeller to the casing through the shaft regulation system (Group III only) or replace the impeller. |
|  | The discharge valve is closed.   | Open the discharge valve.  |
|  | Two-phase motor operation.   | Check the motor's electrical power supply.   |
|  | The speed of rotation is low.  | Check the wiring.  |
|  | The sense of rotation is wrong.  | Check the wiring.  |
| The frequency is not suitable for the pump.                            | Check the frequency.   |  |
| INSUFFICIENT FLOW OR PRESSURE  | Air pockets are in the piping.   | Check the piping conditions.   |
|  | The liquid contains air or gas.  | Check the liquid conditions.   |
|  | Foreign bodies obstruct the impeller or the suction or discharge piping.   | Remove the foreign bodies.   |
|  | The impeller is worn or damaged or the distance between the impeller and the casing is greater than recommended. | Close the impeller to the casing through the shaft regulation system (Group III only) or replace the impeller. |
|  | Total head of the plant greater then the head of the pump.   | Check losses and condition of the plant.   |
|  | The viscosity of the liquid is higher then design values.  | Check the specific gravity, temperature and viscosity values.  |
|  | The speed of rotation is low.  | Check the wiring.  |
|  | The sense of rotation is wrong.  | Check the wiring.  |
| The frequency is not suitable for the pump.                            | Check the frequency.   |  |
| PUMP VIBRATES EXCESSIVELY  | The pump cavitating.   | Check the plant conditions and the causes of the cavitation.   |
|  | Duty point outside the recommended flow rate.  | Regulate the duty point according the recommended flow rate.   |
|  | Foreign bodies obstruct the impeller or the suction or discharge piping.   | Remove the foreign bodies.   |
|  | One or some parts of the pump are damaged or worn.   | Disassembly the pump and replace the damaged or worn parts.  |
|  | The motor bearings are worn.   | Replace the motor bearing.   |
|  | The baseplate is not anchored firmly.  | Anchor the baseplate firmly to a reinforced concrete base.   |
| The installation screws are not tightened.                             | Tighten the bolts.   |  |
| THE MOTOR IS OVERHEATED  | The discharge valve is too open.   | Regulate the discharge valve according the declared duty point.  |
|  | The specific gravity or viscosity of the liquid are higher then design values.                                   | Check the specific gravity and viscosity values.   |
|  | The ambient temperature is too high.   | Install the motor providing a minimum distance from other objects and supplying a proper ventilation.          |
|  | The speed of rotation is high.   | Check the wiring.  |
|  | Excessive compression of the elastic element on the mechanical sealing.  | Contact AFFETTI.   |
|  | The bearings of the motor are defective.   | Replace the bearings of the motor.   |
| Pump and motor are not aligned correctly.                              | Realign the pump unit.   |  |
| RAPID WEAR OF MECHANICAL SEAL  | The flushing or pumped liquid contains foreign bodies or abrasive substances.                                    | Check that the percentage of solid particles does not exceed the maximum amount allowed for the application.   |
|  | The materials of the mechanical seal are not compatible with the liquid.   | Contact AFFETTI.   |
|  | The pumped liquid causes the formation of air or gas.  | Contact AFFETTI.   |
|  | Duty point outside the recommended flow rate.  | Regulate the duty point according the recommended flow rate.   |
|  | Dry run operation.   | Check the installation and operation of the pump.  |
| The pump and motor are not aligned correctly.                          | Realign the pump unit.   |  |

**NOTE:** Contact the manufacturer in case the failure reason has not been found.

## 7.0 COMPONENTS LIST

### 7.1 EXPLODED VIEW

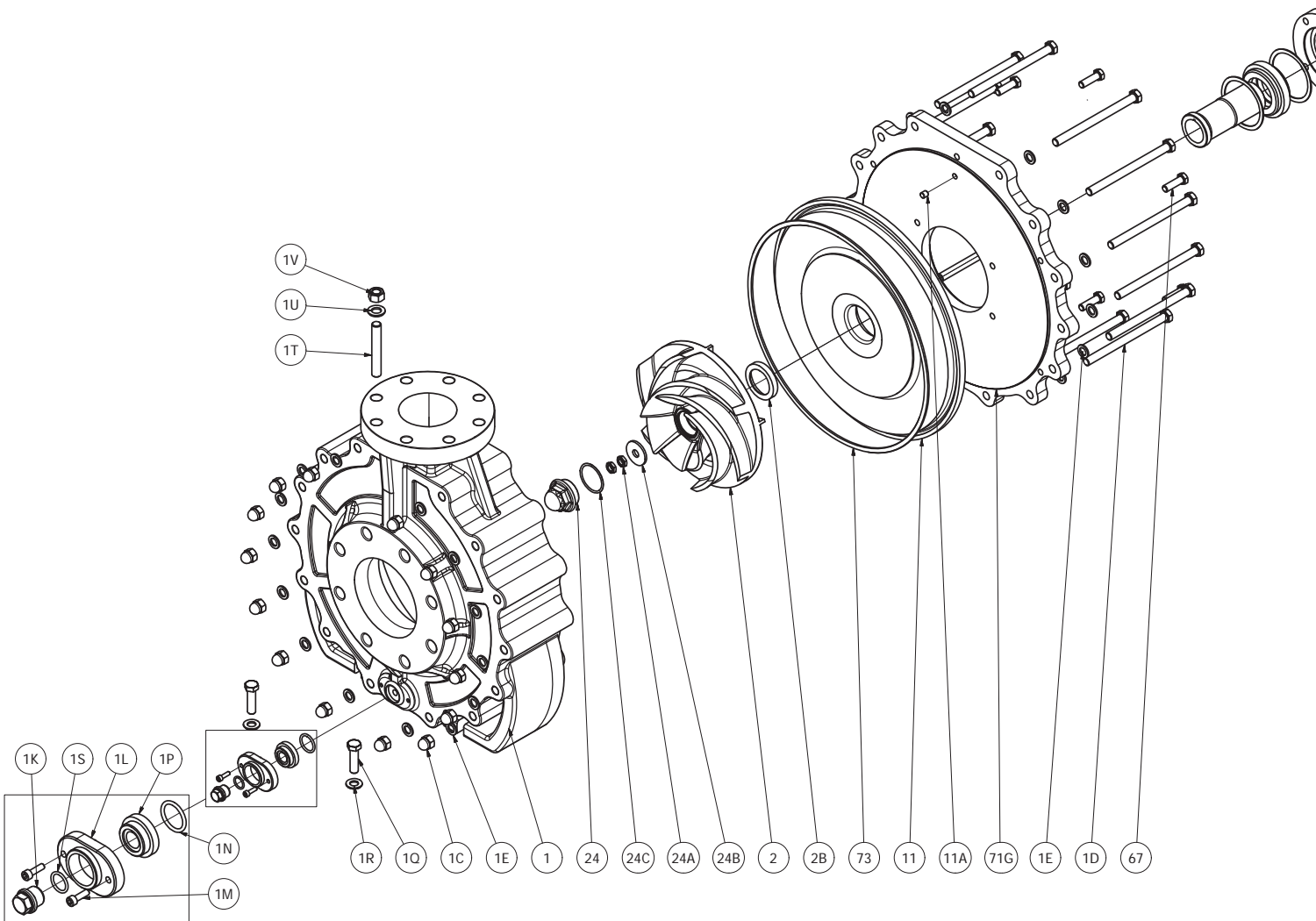

Detail: Drainage (optional)



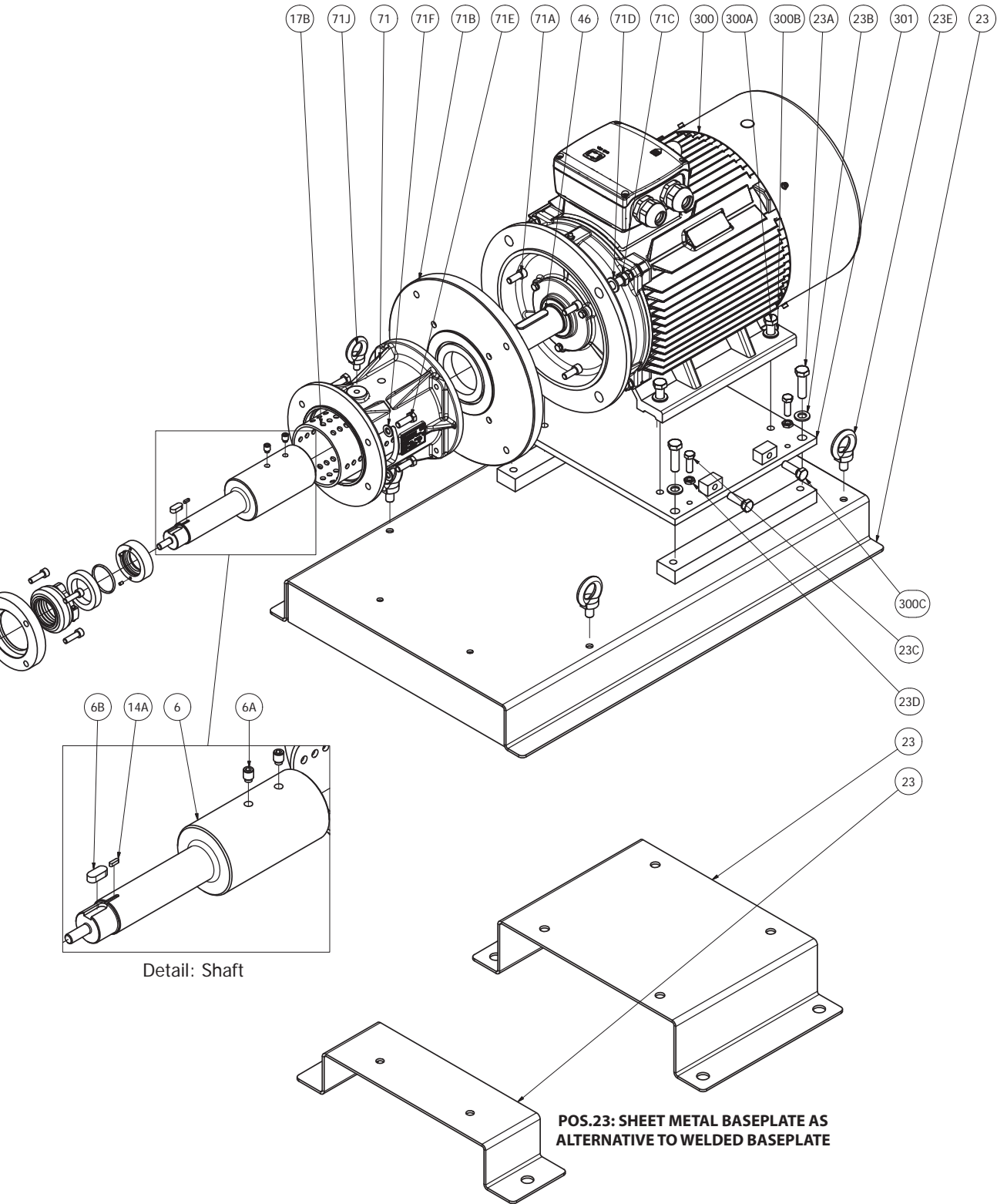

Detail: Shaft

**POS.23: SHEET METAL BASEPLATE AS ALTERNATIVE TO WELDED BASEPLATE**

**NOTE:** The drip-pan of the baseplate is not represented. For detailed view please send a request to the manufacturer.

**NOTE:** All parts of mechanical seals are shown on pages 32-36.

**NOTE:** Nomenclature and definitions of parts are according to ANSI/HI 1.1-1.2-2008 standards.

7.2 SECTIONAL VIEW WITH JRS / JRS1 MECHANICAL SEAL

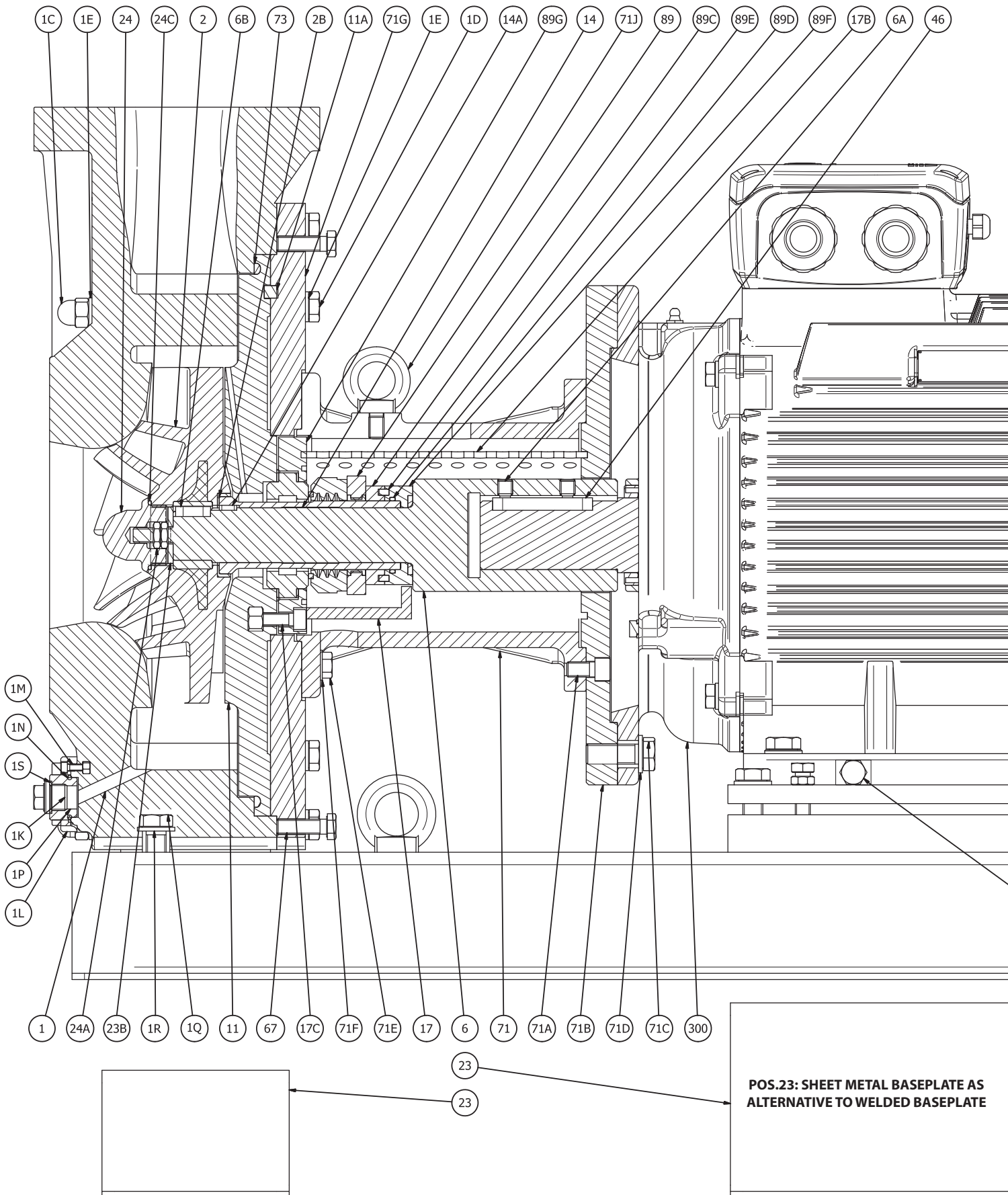

**NOTE:** The drip-pan of the baseplate is not represented. For detailed view please send a request to the manufacturer.

**NOTE:** All parts of mechanical seals are shown on pages 32-36.

**NOTE:** Nomenclature and definitions of parts are according to ANSI/HI 1.1-1.2-2008 standards.

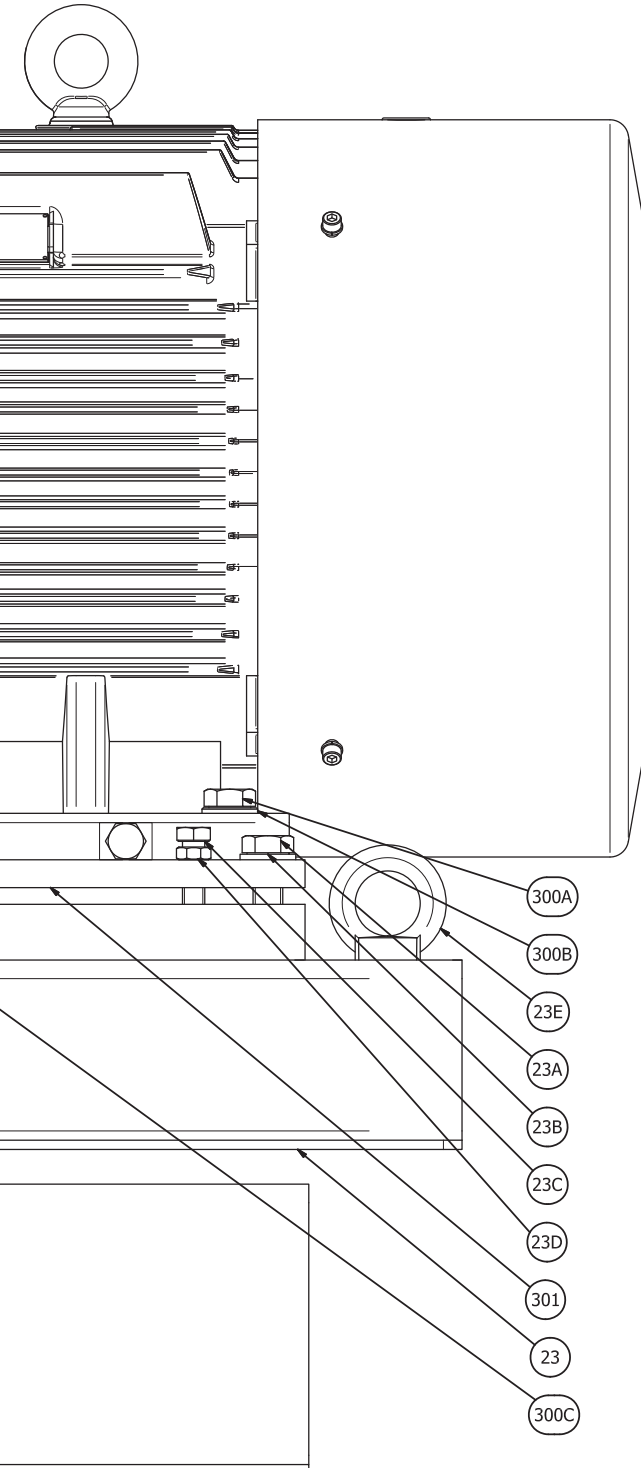

### 7.3 PART LIST OF THE PUMP UNIT

| POS. | DESCRIPTION                          | QUANTITY | MATERIAL                              |
|------|--------------------------------------|----------|---------------------------------------|
| 1    | Casing                               | 1        | FRP                                   |
| 1C   | Nut, casing                          | 6 - 16   | SS 316                                |
| 1D   | Screw, casing                        | 6 - 16   | SS 316                                |
| 1E   | Washer, casing                       | 12 - 32  | SS 316                                |
| 1K   | Plug, drainage *                     | 1        | PVC                                   |
| 1L   | Cover, drainage *                    | 1        | S275JR                                |
| 1M   | Screw, drainage *                    | 2        | SS 316                                |
| 1N   | O-ring, drainage *                   | 1        | EPDM - FPM - FEP - FFKM               |
| 1P   | Bushing for drainage *               | 1        | PVC                                   |
| 1Q   | Screw, casing                        | 2        | SS 316                                |
| 1R   | Washer, casing                       | 2        | SS 316                                |
| 1S   | O-ring, drainage *                   | 1        | EPDM - FPM - FEP - FFKM               |
| 1T   | Stud, casing <sup>(1)</sup>          | 4        | SS 316                                |
| 1U   | Washer, casing <sup>(1)</sup>        | 4        | SS 316                                |
| 1V   | Nut, casing <sup>(1)</sup>           | 4        | SS 316                                |
| 2    | Impeller                             | 1        | FRP                                   |
| 2B   | Gasket, impeller <sup>(1)</sup>      | 1        | EPDM - FPM - PTFE                     |
| 6    | Shaft                                | 1        | 42CrMo4 - Super Duplex <sup>(3)</sup> |
| 6A   | Socket set screw, shaft              | 2        | SS 304 / 316                          |
| 6B   | Key - shaft, impeller                | 1        | C45 or SS 304 / 316 <sup>(3)</sup>    |
| 11   | Cover                                | 1        | PE-UHMMW or FRP                       |
| 11A  | Cylindric pin, cover                 | 1        | SS 304                                |
| 14   | Shaft sleeve                         | 1        | FRP                                   |
| 14A  | Key, shaft sleeve                    | 1        | C45 or SS 304 / 316 <sup>(3)</sup>    |
| 17   | Gland                                | 1        | PP or FRP                             |
| 17B  | External protection <sup>(4)</sup>   | 1        | PMMA                                  |
| 17C  | Screw, gland                         | 4        | SS 316                                |
| 17E  | Washer, gland                        | 4        | SS 316                                |
| 23   | Baseplate                            | 1        | S275JR or SS 304                      |
| 23A  | Screw, baseplate                     | 4        | SS 316                                |
| 23B  | Washer, baseplate                    | 4        | SS 316                                |
| 23C  | Spacing screw, baseplate             | 4        | SS 316                                |
| 23D  | Nut, baseplate                       | 4        | SS 316                                |
| 23E  | Handle, baseplate                    | 4        | Cast iron                             |
| 24   | Impeller nut                         | 1        | FRP                                   |
| 24A  | Locknut, impeller <sup>(2)</sup>     | 2        | SS 316                                |
| 24B  | Washer, impeller <sup>(2)</sup>      | 1        | 42CrMo4                               |
| 24C  | O-Ring, nut                          | 1        | EPDM - FPM - FEP - FFKM               |
| 46   | Key, motor <sup>(5)</sup>            | 1        | C45 or SS 304 / 316 <sup>(3)</sup>    |
| 67   | Spacing screw, casing                | 4-6      | SS 316                                |
| 71   | Frame                                | 1        | S275JR                                |
| 71A  | Screw, frame adaptor                 | 4        | SS 316                                |
| 71B  | Frame adaptor                        | 1        | S275JR                                |
| 71C  | Screw, frame adaptor                 | 4        | SS 316                                |
| 71D  | Washer, frame adaptor                | 4        | SS 316                                |
| 71E  | Screw, frame                         | 4        | SS 316                                |
| 71F  | Washer, frame                        | 4        | SS 316                                |
| 71G  | Frame adaptor                        | 1        | S275JR                                |
| 71J  | Handle, frame                        | 1        | Cast iron                             |
| 73   | O-Ring, cover                        | 1        | EPDM - FPM - FEP - FFKM               |
| 89   | Mechanical seal JRS/JRS1             | 1        | SiC-SiC / PTFE                        |
| 89C  | Spacer, seal                         | 1        | PP                                    |
| 89D  | O-Ring, gland                        | 1        | EPDM - FPM - FFKM                     |
| 89E  | Cylindrical pin, gland               | 2        | SS 304                                |
| 89F  | Auxiliary, gland                     | 1        | PP                                    |
| 300  | Motor                                | 1        | Aluminium or Cast iron                |
| 300A | Screw, motor                         | 4        | SS 316                                |
| 300B | Washer, motor                        | 4        | SS 316                                |
| 300C | Spacing screw <sup>(5)</sup> , motor | 4        | SS 316                                |
| 301  | Plate, motor                         | 1        | S275JR                                |

**NOTES:**

\* Optional parts

<sup>(1)</sup> Only for 1,5x1x6 and 1,5x1x8.

<sup>(2)</sup> Only for the Group II and III

<sup>(3)</sup> Special execution on request

<sup>(4)</sup> As alternative to the part 17

<sup>(5)</sup> Only from motor frame 160M

### 7.4 B6EDF - B6EDFC - B6E - B6EC - B6EFL - B6EFLC SEALS

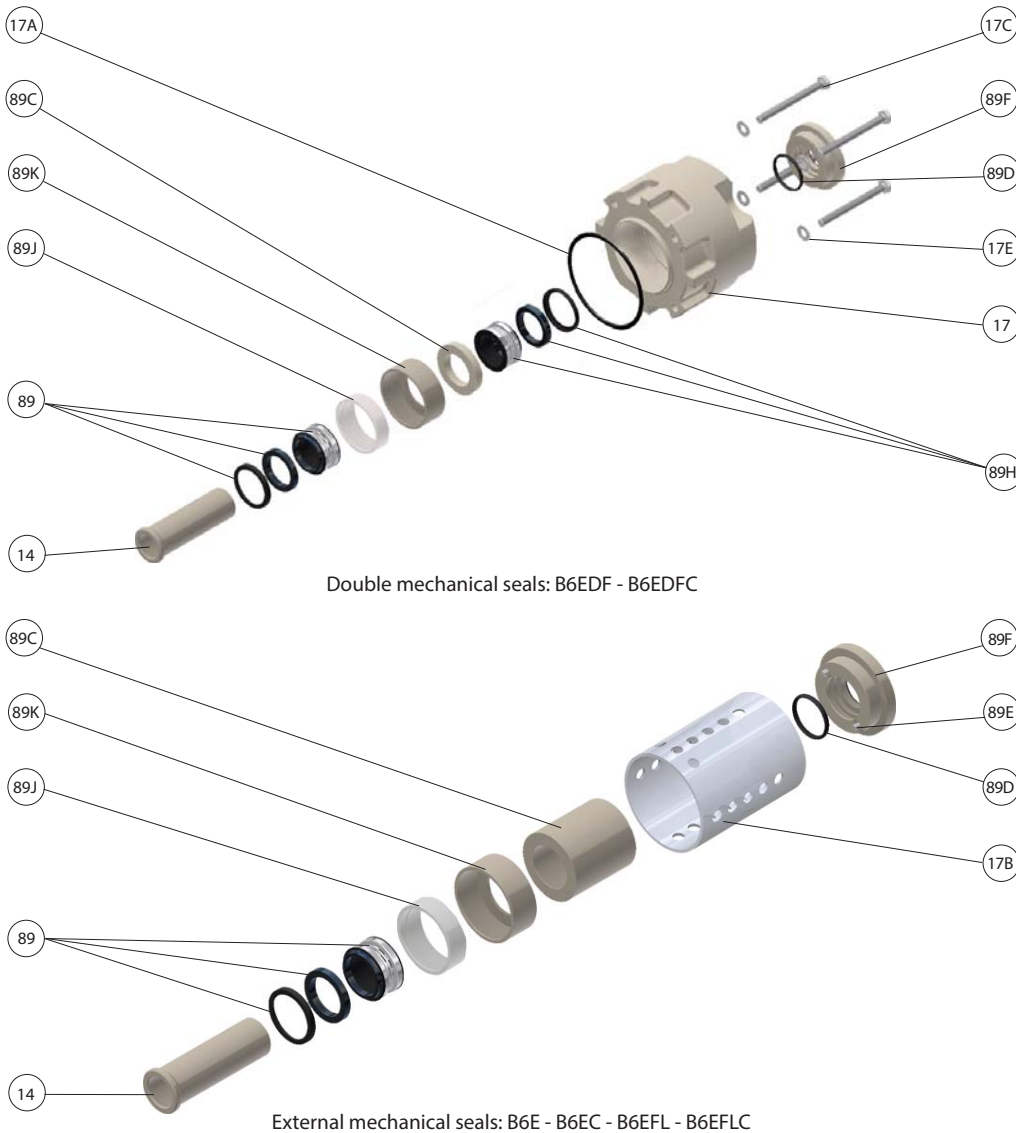

Double mechanical seals: B6EDF - B6EDFC

External mechanical seals: B6E - B6EC - B6EFL - B6EFLC

Positioning of the mechanical seal

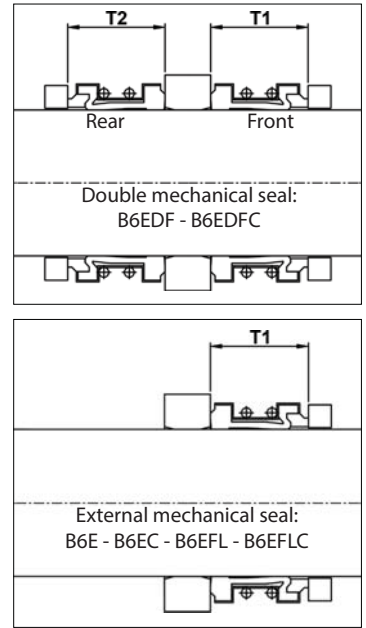

| Seals diameter (mm) | T1 (mm) |
|---------------------|---------|
| 35                  | 26      |
| 55                  | 30      |
| 75                  | 40      |
| Seals diameter (mm) | T2 (mm) |
| 35                  | 26      |
| 55                  | 30      |
| 75                  | 40      |

#### NOMENCLATURE OF MECHANICAL SEAL PARTS

| POS. | DESCRIPTION              | QUANTITY | MATERIAL                      |
|------|--------------------------|----------|-------------------------------|
| 14   | Shaft sleeve             | 1        | FRP or PE-UHMW                |
| 17   | Gland                    | 1        | FRP or PVC                    |
| 17A  | O-Ring, gland            | 1        | EPDM - FPM - FFKM             |
| 17B  | External protection      | 1        | PMMA                          |
| 17C  | Screw, gland             | 4        | SS 316                        |
| 17E  | Washer, gland            | 4        | SS316                         |
| 89   | Mechanical seal          | 1        | EPDM or FPM - SS316 - SIC/SIC |
| 89C  | Spacer, seal             | 1        | PP                            |
| 89D  | O-Ring, gland            | 1        | EPDM - FPM - FFKM             |
| 89E  | Cylindrical pin, gland   | 2        | SS 304                        |
| 89F  | Deflector, gland         | 1        | PP                            |
| 89H  | Mechanical seal          | 1        | EPDM or FPM - SS316 - SIC/SIC |
| 89K  | Ext. reinforcement, seal | 1        | PP                            |
| 89J  | Int. reinforcement, seal | 1        | PVDF                          |

#### B6EDF - B6EDFC MECHANICAL SEAL TECHNICAL DATA

| Seal diameter (mm) | Temperature range (°C) | Max. pressure (Bar g) | Max. RPM |
|--------------------|------------------------|-----------------------|----------|
| 35                 | -40 / +40              | 6,5                   | 3500     |
|                    | -40 / +60              | 5                     |          |
| 55                 | -40 / +60              | 4                     | 1780     |
|                    | -40 / +35              | 3                     |          |
| 75                 | -40 / +60              | 2                     | 1780     |
|                    | -40 / +35              | 3                     |          |

APPLICABLE API PLANS: 7301 - 7311 - 7312 - 7332 + 7352 - 7353 - 7354

#### B6E - B6EC - B6EFL - B6EFLC MECHANICAL SEAL TECHNICAL DATA

| Seal diameter (mm) | Temperature range (°C) | Max. pressure (Bar g) | Max. RPM |
|--------------------|------------------------|-----------------------|----------|
| 35                 | -40 / +40              | 6,5                   | 3500     |
|                    | -40 / +60              | 5                     |          |
| 55                 | -40 / +60              | 4                     | 1780     |
|                    | -40 / +35              | 3                     |          |
| 75                 | -40 / +60              | 2                     | 1780     |
|                    | -40 / +35              | 3                     |          |

APPLICABLE API PLANS: 7301 - 7311 - 7312 - 7332

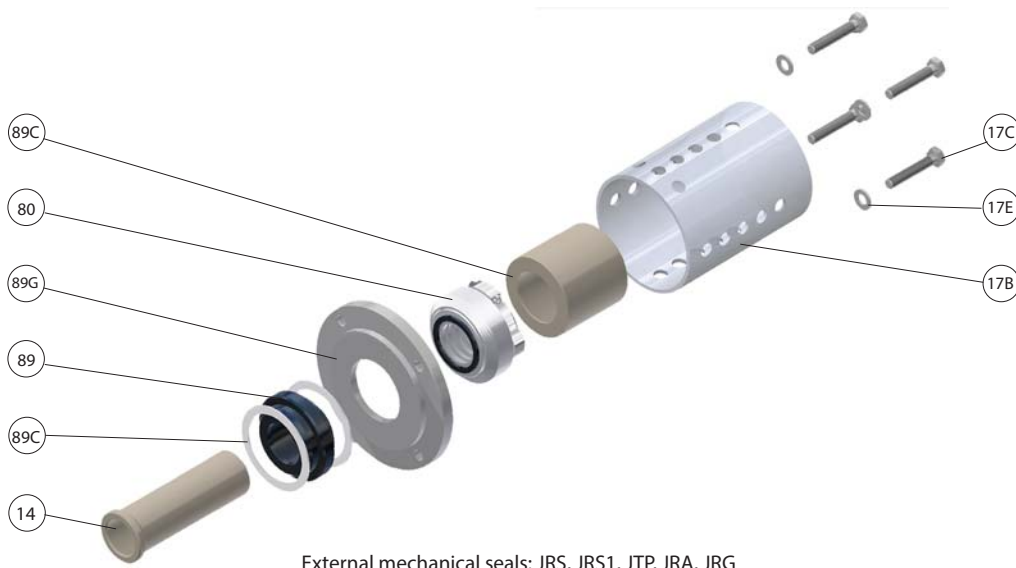
**7.5 JRS - JRS1 - JTP - JRA - JRG SEALS**

External mechanical seals: JRS, JRS1, JTP, JRA, JRG

Positioning of the mechanical seal

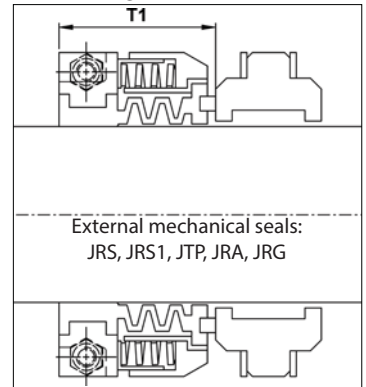

| Seals diameter (mm) | T1 (mm) |
|---------------------|---------|
| 35                  | 38      |
| 55                  | 53      |
| 75                  | 53      |

**NOMENCLATURE OF MECHANICAL SEAL PARTS**

| POS. | DESCRIPTION                          | QUANTITY | MATERIAL                          |
|------|--------------------------------------|----------|-----------------------------------|
| 14   | Shaft sleeve                         | 1        | FRP or PE-UHMW                    |
| 17B  | External protection                  | 1        | PMMA                              |
| 17C  | Screw, gland                         | 4        | SS 316                            |
| 17E  | Washer, gland                        | 4        | SS 316                            |
| 80   | Mechanical seal JRS (rotating ring)  | 1        | SS 316 - PTFE C - SiC             |
|      | Mechanical seal JRS1 (rotating ring) | 1        | SS 316 - PTFE C - SiC             |
|      | Mechanical seal JTP (rotating ring)  | 1        | SS 316 - PTFE C - PTFE C          |
|      | Mechanical seal JRA (rotating ring)  | 1        | SS 316 - PTFE C - SiC             |
|      | Mechanical seal JRG (rotating ring)  | 1        | SS 316 - PTFE C - Carbon-graphite |
| 89   | Mechanical seal JRS (static ring)    | 1        | SiC                               |
|      | Mechanical seal JRS1 (static ring)   | 1        | SiC                               |
|      | Mechanical seal JTP (static ring)    | 1        | Al <sub>2</sub> O <sub>3</sub>    |
|      | Mechanical seal JRA (static ring)    | 1        | Al <sub>2</sub> O <sub>3</sub>    |
|      | Mechanical seal JRG (static ring)    | 1        | Al <sub>2</sub> O <sub>3</sub>    |
| 89A  | Seal, gland                          | 2        | PTFE                              |
| 89C  | Spacer, seal                         | 1        | PP                                |
| 89G  | Retaining ring                       | 1        | SS 316                            |

**JRS MECHANICAL SEAL TECHNICAL DATA**

| Seal diameter (mm)                              | Temperature range (°C) | Max. pressure (Bar g) | Max. RPM |
|---|------------------------|-----------------------|----------|
| 35  | -45 / +90              | 8                     | 3500     |
| 55  |                        |                       |          |
| 75  |                        | 7                     | 1780     |
| APPLICABLE API PLANS: 7301 – 7311 – 7312 – 7332 |                        |                       |          |

**JRS1 MECHANICAL SEAL TECHNICAL DATA**

| Seal diameter (mm)                              | Temperature range (°C) | Max. pressure (Bar g) | Max. RPM |
|---|------------------------|-----------------------|----------|
| 35  | -30 / +90              | 7                     | 3500     |
| 55  |                        | 6                     |          |
| 75  |                        | 5                     | 1780     |
| APPLICABLE API PLANS: 7301 – 7311 – 7312 – 7332 |                        |                       |          |

**JTP MECHANICAL SEAL TECHNICAL DATA**

| Seal diameter (mm)                              | Temperature range (°C) | Max. pressure (Bar g) | Max. RPM |
|---|------------------------|-----------------------|----------|
| 35  | -45 / +95              | 8                     | 3500     |
| 55  |                        |                       |          |
| 75  |                        | 7                     | 1780     |
| APPLICABLE API PLANS: 7301 – 7311 – 7312 – 7332 |                        |                       |          |

**JRA - JRG MECHANICAL SEAL TECHNICAL DATA**

| Seal diameter (mm)                              | Temperature range (°C) | Max. pressure (Bar g) | Max. RPM |
|---|------------------------|-----------------------|----------|
| 35  | -45 / +90              | 8                     | 3500     |
| 55  |                        |                       |          |
| 75  |                        | 7                     | 1780     |
| APPLICABLE API PLANS: 7301 – 7311 – 7312 – 7332 |                        |                       |          |



### 7.6 JR2S - JR2S1 - JT2P - JR2A - JR2G SEALS

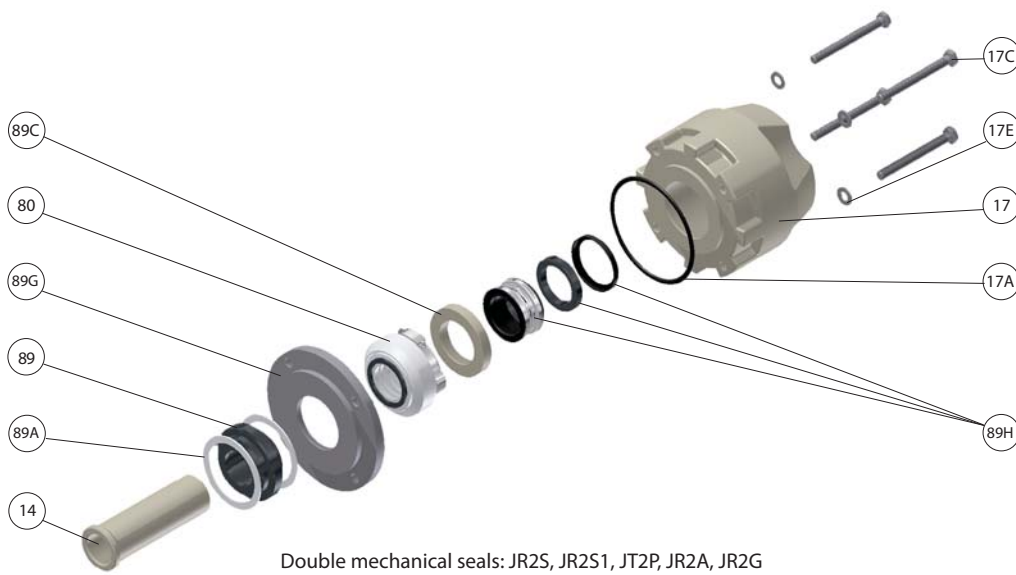

Positioning of the mechanical seal

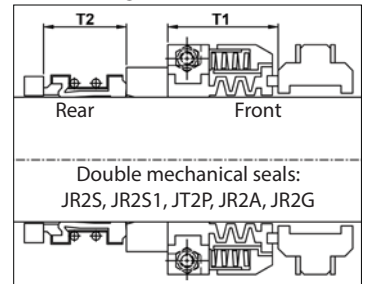

| Seals diameter (mm) | T1 (mm) |
|---------------------|---------|
| 35                  | 38      |
| 55                  | 53      |
| 75                  | 53      |
| Seals diameter (mm) | T2 (mm) |
| 35                  | 26      |
| 55                  | 30      |
| 75                  | 40      |

#### NOMENCLATURE OF MECHANICAL SEAL PARTS

| POS. | DESCRIPTION                           | QUANTITY | MATERIAL                          |
|------|---------------------------------------|----------|-----------------------------------|
| 14   | Shaft sleeve                          | 1        | FRP or PE-UHMW                    |
| 17   | Gland                                 | 1        | FRP or PVC                        |
| 17A  | O-Ring, gland                         | 1        | EPDM - FPM - FFKM                 |
| 17C  | Screw, gland                          | 4        | SS 316                            |
| 17E  | Washer, gland                         | 4        | SS 316                            |
| 80   | Mechanical seal J2RS (rotating ring)  | 1        | SS 316 - PTFE C - SiC             |
|      | Mechanical seal J2RS1 (rotating ring) | 1        | SS 316 - PTFE C - SiC             |
|      | Mechanical seal J2TP (rotating ring)  | 1        | SS 316 - PTFE C - PTFE C          |
|      | Mechanical seal J2RA (rotating ring)  | 1        | SS 316 - PTFE C - SiC             |
|      | Mechanical seal J2RG (rotating ring)  | 1        | SS 316 - PTFE C - Carbon-graphite |
| 89   | Mechanical seal JR2S (static ring)    | 1        | SiC                               |
|      | Mechanical seal JR2S1 (static ring)   | 1        | SiC                               |
|      | Mechanical seal J2TP (static ring)    | 1        | Al <sub>2</sub> O <sub>3</sub>    |
|      | Mechanical seal J2RA (static ring)    | 1        | Al <sub>2</sub> O <sub>3</sub>    |
|      | Mechanical seal J2RG (static ring)    | 1        | Al <sub>2</sub> O <sub>3</sub>    |
| 89A  | Seal, gland                           | 2        | PTFE                              |
| 89C  | Spacer                                | 1        | PP                                |
| 89G  | Retaining ring                        | 1        | SS 316                            |
| 89H  | Mechanical seal                       | 1        | EPDM o FPM - SS 316 - SiC/SiC     |

#### JR2S MECHANICAL SEAL TECHNICAL DATA

| Seal diameter (mm) | Temperature range (°C) | Max. pressure (Bar g) | Max. RPM |
|--------------------|------------------------|-----------------------|----------|
| 35                 | -45 / +90              | 8                     | 3500     |
| 55                 |                        |                       |          |
| 75                 |                        | 7                     | 1780     |

APPLICABLE API PLANS: 7301 – 7311 – 7312 – 7332 + 7352 – 7353 – 7354

#### JR2S1 MECHANICAL SEAL TECHNICAL DATA

| Seal diameter (mm) | Temperature range (°C) | Max. pressure (Bar g) | Max. RPM |
|--------------------|------------------------|-----------------------|----------|
| 35                 | -30 / +90              | 7                     | 3500     |
| 55                 |                        | 6                     |          |
| 75                 |                        | 5                     | 1780     |

APPLICABLE API PLANS: 7301 – 7311 – 7312 – 7332 + 7352 – 7353 – 7354

#### JT2P MECHANICAL SEAL TECHNICAL DATA

| Seal diameter (mm) | Temperature range (°C) | Max. pressure (Bar g) | Max. RPM |
|--------------------|------------------------|-----------------------|----------|
| 35                 | -45 / +95              | 8                     | 3500     |
| 55                 |                        |                       |          |
| 75                 |                        | 7                     | 1780     |

APPLICABLE API PLANS: 7301 – 7311 – 7312 – 7332 + 7352 – 7353 – 7354

#### JR2A - JR2G MECHANICAL SEALS TECHNICAL DATA

| Seal diameter (mm) | Temperature range (°C) | Max. pressure (Bar g) | Max. RPM |
|--------------------|------------------------|-----------------------|----------|
| 35                 | -45 / +90              | 8                     | 3500     |
| 55                 |                        |                       |          |
| 75                 |                        | 7                     | 1780     |

APPLICABLE API PLANS: 7301 – 7311 – 7312 – 7332 + 7352 – 7353 – 7354

### 7.7 B6IDF-B6IDFC-B6IDFH-B6I-B6IC-B6IH-B6IFL-B6IFLH-B6IFLC SEALS

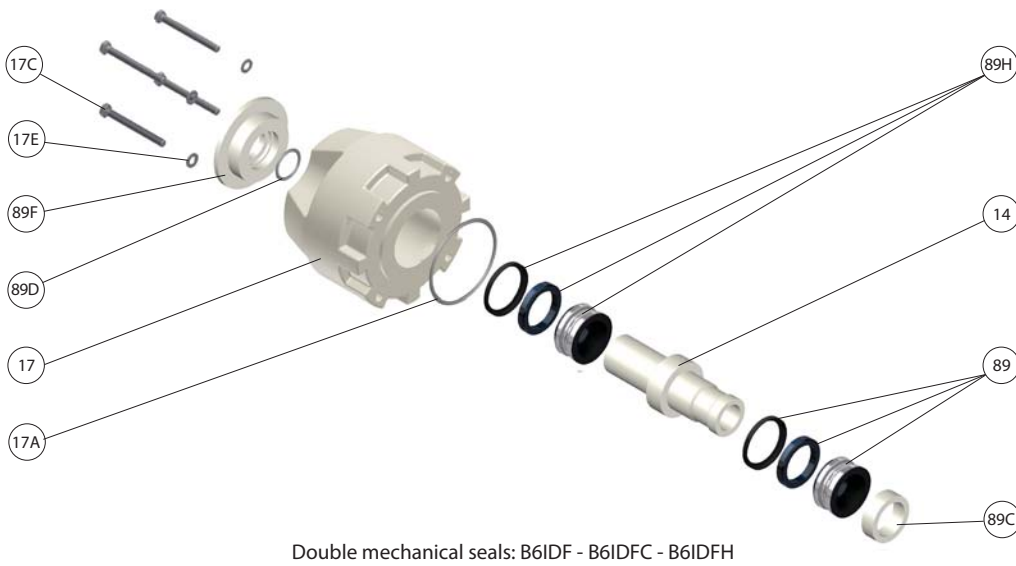

Double mechanical seals: B6IDF - B6IDFC - B6IDFH

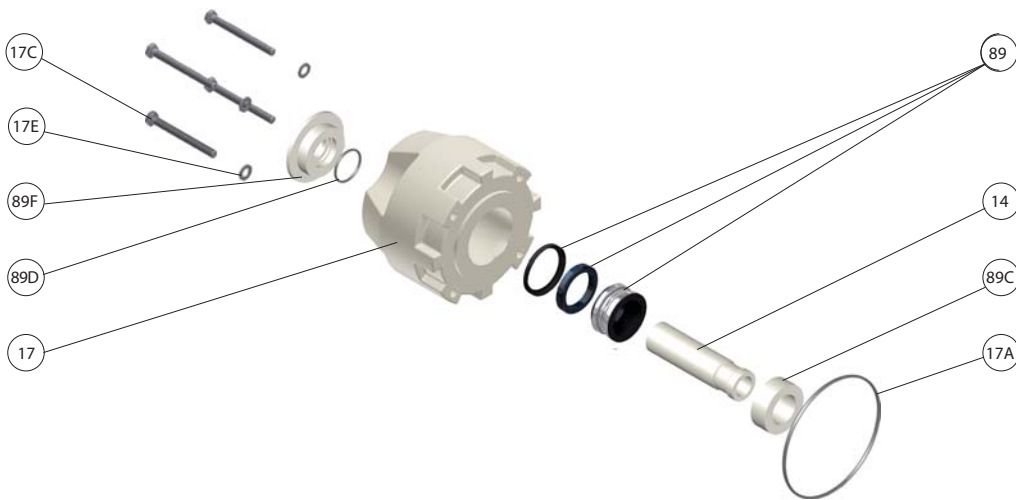

Internal mechanical seals: B6I - B6IC - B6IH - B6IFL - B6IFLC - B6IFLH

Positioning of the mechanical seal

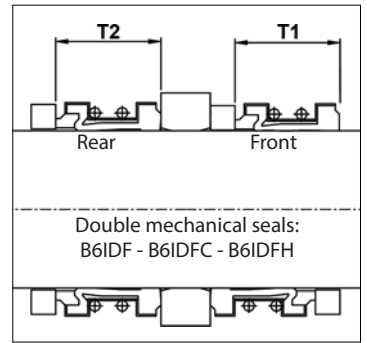

Double mechanical seals:  
B6IDF - B6IDFC - B6IDFH

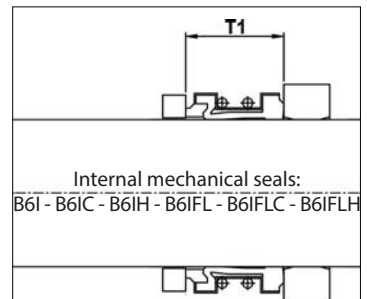

Internal mechanical seals:  
B6I - B6IC - B6IH - B6IFL - B6IFLC - B6IFLH

| Seals diameter (mm) | T1 (mm) |
|---------------------|---------|
| 35                  | 26      |
| 55                  | 30      |
| 75                  | 40      |
| Seals diameter (mm) | T2 (mm) |
| 35                  | 26      |
| 55                  | 30      |
| 75                  | 40      |

#### NOMENCLATURE OF MECHANICAL SEAL PARTS

| POS. | DESCRIPTION      | QUANTITY | MATERIAL                       |
|------|------------------|----------|--------------------------------|
| 14   | Shaft sleeve     | 1        | FRP or PE-UHMW                 |
| 17   | Gland            | 1        | FRP or PVC                     |
| 17A  | O-Ring, gland    | 1        | EPDM - FPM - FFKM              |
| 17C  | Screw, gland     | 4        | SS 316                         |
| 17E  | Washer, gland    | 4        | SS 316                         |
| 89   | Mechanical seal  | 1        | EPDM or FPM - SS 316 - SiC/SiC |
| 89C  | Spacer, seal     | 1        | PP                             |
| 89D  | O-ring, gland    | 1        | EPDM - FPM - FFKM              |
| 89F  | Deflector, gland | 1        | PP                             |
| 89H  | Mechanical seal  | 1        | EPDM or FPM - SS 316 - SiC/SiC |

#### MECHANICAL SEAL TECHNICAL DATA B6IDF - B6IDFC - B6IDFH

| Seal diameter (mm) | Temperature range (°C) | Max. pressure (Bar g) | Max. RPM |
|--------------------|------------------------|-----------------------|----------|
| 35                 | -40 / +60              | 10                    | 3500     |
| 55                 |                        | 8,5                   |          |
| 75                 |                        |                       | 1780     |

APPLICABLE API PLANS: 7301 - 7311 - 7312 - 7332 + 7352 - 7353 - 7354

#### MECHANICAL SEAL TECHNICAL DATA B6I - B6IC - B6IH - B6IFL - B6IFLC

| Seal diameter (mm) | Temperature range (°C) | Max. pressure (Bar g) | Max. RPM |
|--------------------|------------------------|-----------------------|----------|
| 35                 | -40 / +60              | 10                    | 3500     |
| 55                 |                        | 8,5                   |          |
| 75                 |                        |                       | 1780     |

APPLICABLE API PLANS: 7301 - 7311 - 7312 - 7332

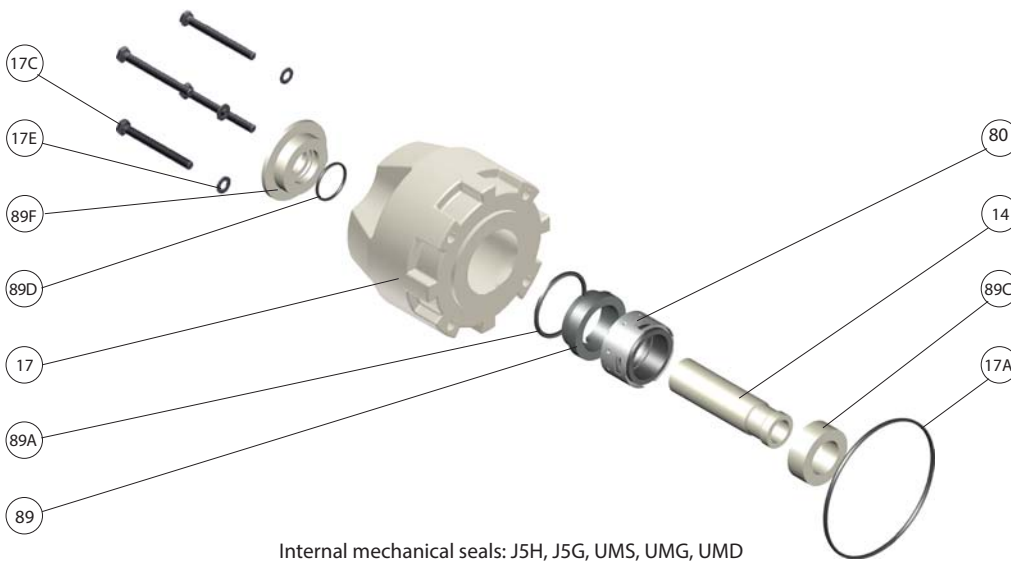
**7.8 J5H - J5G - UMS - UMG - UMD SEALS**

Positioning of the mechanical seal

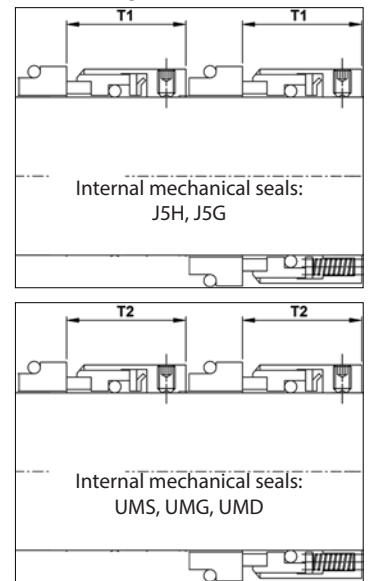

| Seal's diameter (mm) | T1 (mm) | T2 (mm) |
|----------------------|---------|---------|
| 35                   | 30.5    | 32.5    |
| 55                   | 34      | 34.5    |
| 75                   | 45.5    | 45      |

**NOMENCLATURE OF MECHANICAL SEAL PARTS**

| POS. | DESCRIPTION                         | QUANTITY | MATERIAL                                       |
|------|-------------------------------------|----------|--|
| 14   | Shaft sleeve                        | 1        | FRP or PE-UHMW                                 |
| 17   | Gland                               | 1        | FRP or PVC                                     |
| 17A  | O-Ring, gland                       | 1        | EPDM - FPM - FFKM                              |
| 17C  | Screw, gland                        | 4        | SS 316   |
| 17E  | Washer, gland                       | 4        | SS 316   |
| 80   | Mechanical seal J5H (rotating ring) | 1        | EPDM or FPM - SiC - Monel 400 - Hastelloy C276 |
|      | Mechanical seal J5G (rotating ring) | 1        | EPDM or FPM - Carbon-graphite - SS 316         |
|      | Mechanical seal UMS (rotating ring) | 1        | EPDM or FPM - SiC - Hastelloy C276             |
|      | Mechanical seal UMG (rotating ring) | 1        | EPDM or FPM - Carbon-graphite - Hastelloy C276 |
|      | Mechanical seal UMD (rotating ring) | 1        | SiC - Hastelloy C276 - Duplex                  |
| 89   | Mechanical seal J5H (static ring)   | 1        | SiC  |
|      | Mechanical seal J5G (static ring)   | 1        | SiC  |
|      | Mechanical seal UMS (static ring)   | 1        | SiC  |
|      | Mechanical seal UMG (static ring)   | 1        | SiC  |
|      | Mechanical seal UMD (static ring)   | 1        | SiC  |
| 89A  | O-Ring, seal                        | 1        | EPDM - FPM                                     |
| 89C  | Spacer                              | 1        | PP   |
| 89D  | O-Ring, gland                       | 1        | EPDM - FPM - FFKM                              |
| 89F  | Deflector, gland                    | 1        | PP   |

**J5H MECHANICAL SEAL TECHNICAL DATA**

| Seal diameter (mm) | Temperature range (°C) | Max. pressure (Bar g) | Max. RPM |
|--------------------|------------------------|-----------------------|----------|
| 35                 | -40 / +80              | 12                    | 3500     |
| 55                 |                        |                       |          |
| 75                 |                        | 10                    | 1780     |

APPLICABLE API PLANS: 7301 – 7311 – 7312 – 7332

**J5G MECHANICAL SEAL TECHNICAL DATA**

| Seal diameter (mm) | Temperature range (°C) | Max. pressure (Bar g) | Max. RPM |
|--------------------|------------------------|-----------------------|----------|
| 35                 | -40 / +90              | 12                    | 3500     |
| 55                 |                        |                       |          |
| 75                 |                        | 10                    | 1780     |

APPLICABLE API PLANS: 7301 – 7311 – 7312 – 7332

**UMS - UMD MECHANICAL SEAL TECHNICAL DATA**

| Seal diameter (mm) | Temperature range (°C) | Max. pressure (Bar g) | Max. RPM |
|--------------------|------------------------|-----------------------|----------|
| 35                 | -40 / +80              | 12                    | 3500     |
| 55                 |                        |                       |          |
| 75                 |                        | 10                    | 1780     |

APPLICABLE API PLANS: 7301 – 7311 – 7312 – 7332

**UMG MECHANICAL SEAL TECHNICAL DATA**

| Seal diameter (mm) | Temperature range (°C) | Max. pressure (Bar g) | Max. RPM |
|--------------------|------------------------|-----------------------|----------|
| 35                 | -40 / +90              | 12                    | 3500     |
| 55                 |                        |                       |          |
| 75                 |                        | 10                    | 1780     |

APPLICABLE API PLANS: 7301 – 7311 – 7312 – 7332



## 8.0 AUXILIARY COMPONENTS

### 8.1 SYMBOLS LEGEND AND NOTES

**INLET** Inlet (auxiliary flushing)

**OUTLET** Outlet (auxiliary flushing)

 Manual control valve for pressure and flow rate adjustment

 Check valve

 Pressure and flow rate adjustment orifice

 Y filter

 Pressure indicator

 Temperature indicator

 Flow rate indicator

 Level indicator

 PS Pressure switch

 LS Level sensor

**NOTE:** A double seal API PLAN is always combined with a single seal API PLAN. Example 7301+7352 or 7312+7353 or 7332+7354.

 The auxiliary flushing liquid should always be compatible with the pumped liquid and the construction materials of the wetted parts.

### 8.2 FLUSHING SYSTEM FOR SINGLE SEAL: API PLAN 7301

**DESCRIPTION:** internal flushing system supplied as standard that allows liquid pumped from the pump casing to the seal to pass through an internal orifice.  
**USE:** standard operating conditions, excluding the presence of solids and crystals and high temperatures.

**BENEFITS:** improves seal lubrication. Reduces the likelihood of the liquid freezing and reduces the temperature inside the gland. Does not entail prior calculation or additional cost.

**DISADVANTAGES:** cannot be used with dirty or excessively hot liquids. The quantity of liquid must always be checked to ensure that it is enough to cool the gland.

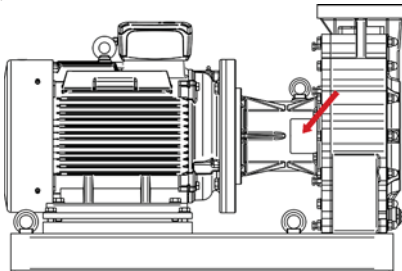

### 8.3 FLUSHING SYSTEM FOR SINGLE SEAL: API PLAN 7311

**DESCRIPTION:** flushing system that recirculates liquid pumped from the discharge to the seal through an orifice for flow rate adjustment.

**USE:** standard operating conditions, excluding the presence of solids and crystals and hot liquids.

**BENEFITS:** the liquid is injected at a higher pressure than that foreseen for Plan 01 (equal to the operating pressure) improving flushing efficiency.  
**DISADVANTAGES:** cannot be used with dirty or excessively hot liquids. The quantity of recirculating liquid must always be checked to ensure that it is enough to cool the gland. The recirculation flow rate and dimension of the orifice must be calculated.

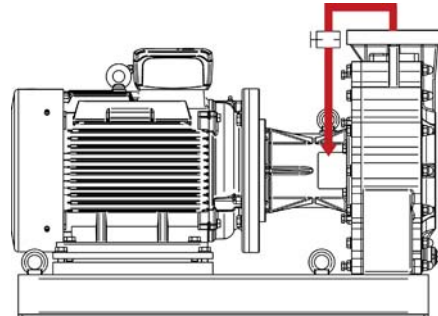

**NOTE:** The orifice must not be smaller than 1/8".

### QUANTITY OF FLUSHING LIQUID

| Seal Ø (mm) | 950 - 1780 RPM   | 2950 - 3500 RPM  | Pressure           |
|-------------|------------------|------------------|--------------------|
| 35          | 1 litres / min   | 1.5 litres / min | Operating pressure |
| 55          | 1.5 litres / min | 2.5 litres / min |                    |
| 75          | 2 litres / min   | -                |                    |

### 8.4 FLUSHING SYSTEM FOR SINGLE SEAL: API PLAN 7312

**DESCRIPTION:** flushing system that recirculates liquid pumped from the discharge to the seal through an orifice and a filter.

**USE:** standard operating conditions, excluding use with hot liquids. Recommended for low concentrations of solids or crystals.

**BENEFITS:** the liquid is injected at a higher pressure than that foreseen for Plan 01 improving flushing efficiency. The filter reduces the presence of solids.

**DISADVANTAGES:** cannot be used with excessively dirty or hot liquids. The quantity of recirculating liquid must always be checked to ensure that it is enough to cool the gland. The recirculation flow rate and dimensions of the orifice and filter must be calculated.

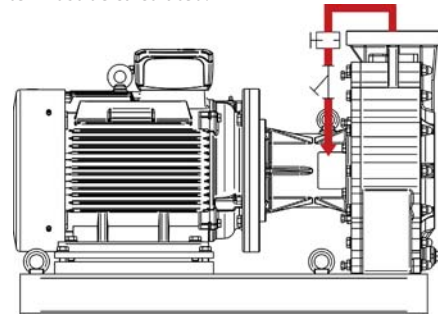

**NOTE:** The strainer must be cleaned periodically.

**NOTE:** The orifice must not be smaller than 1/8".

 Fluid leakages may occur during routine cleaning and/or replacement of the filter. These operations must be carried out when the pump is not in operation and using appropriate safety equipment.

### QUANTITY OF FLUSHING LIQUID

| Seal Ø (mm) | 950 - 1780 RPM   | 2950 - 3500 RPM  | Pressure           |
|-------------|------------------|------------------|--------------------|
| 35          | 1 litres / min   | 1.5 litres / min | Operating pressure |
| 55          | 1.5 litres / min | 2.5 litres / min |                    |
| 75          | 2 litres / min   | -                |                    |



### 8.5 FLUSHING SYSTEM FOR SINGLE SEAL: API PLAN 7332

**DESCRIPTION:** flushing system providing clean liquid from an external source with a temperature ranging from +10°C to +20°C.

**USE:** recommended for liquids containing high concentrations of solids or crystals and for high temperatures.

**BENEFITS:** the use of a flushing system with liquid from an external source extends the life of the mechanical seal, preventing it from leaking or breaking.

**DISADVANTAGES:** the auxiliary flushing liquid is fully dispersed in the liquid pumped (compatibility of the two liquids must be checked before use).

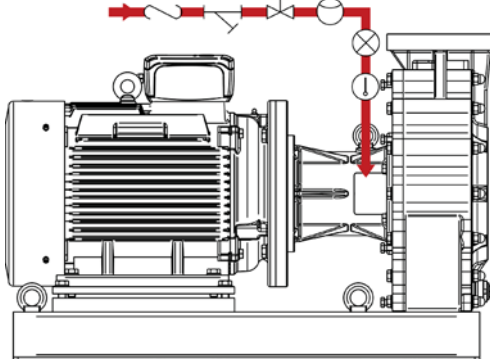

**NOTE:** Flushing of the auxiliary liquid must be continuous, even during start-up and stopping.

#### QUANTITY OF FLUSHING LIQUID

| Seal Ø (mm) | 950 - 1780 RPM   | 2950 - 3500 RPM  | Pressure                                 |
|-------------|------------------|------------------|--|
| 35          | 1 litres / min   | 1.5 litres / min | 1 Bar higher than the operating pressure |
| 55          | 1.5 litres / min | 2.5 litres / min |  |
| 75          | 2 litres / min   | -                |  |

### 8.6 FLUSHING SYSTEM FOR DOUBLE SEAL: API PLAN 7352

**DESCRIPTION:** a non-pressurised, external liquid tank sends clean, cold liquid (+10° / +20°C) to the seal using forced circulation provided by a thermosiphon effect or pumping system.

**USE:** recommended for pumped liquids containing high concentrations of solids or crystals and for high temperatures.

**BENEFITS:** recirculation of liquid through the tank prevents wastage of flushing liquid. PLAN 52 avoids dispersion of the auxiliary liquid into the pumped liquid.

**DISADVANTAGES:** the flushing circuit is complex.

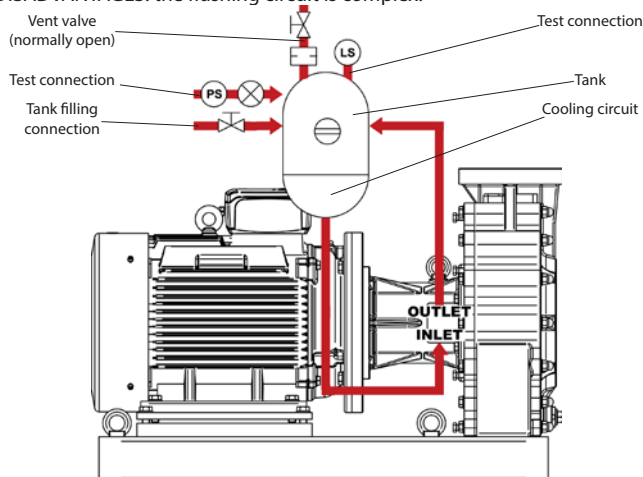

Some installation instructions are given here below:

- The tank must be as close as possible to the pump. A distance of 30 to 45 cm from the shaft axis is recommended. Installation of the tank at a distance of more than a metre is not recommended.
- The capacity of the tank must be consistent with the size of the pump. The minimum capacity should be at least 4 litres for every 25 mm of diameter of the pump shaft. Maintaining a minimum quantity of 8 litres.

- Provide a liquid cooling circuit.
- Install a closure valve on both the OUTLET and INLET piping to the seal so that the tank can be isolated if the pipework needs replacing.
- Pipework should be installed perpendicular to the gland (vertically). If horizontal installation is the only option, make sure that the flushing pipe running to the gland has a gradient of 1° to 5° to prevent air pockets.
- INLET piping running to the seal must have a minimum diameter of 3/4", whilst the OUTLET piping must have a minimum diameter of 1/2".
- Avoid elbows or tight bends along the short stretch of piping.
- Liquid contained within the tank must be topped up at a height of more than 25 mm above the maximum level of liquid contained therein.
- Fit an alarm system that activates a solenoid valve in the event of insufficient pressure inside the inlet piping.
- Provide a drainage hole for emptying the tank.

**NOTE:** Flushing of the auxiliary liquid must be continuous, even during start-up and stopping.

 Vent the tank using a vent valve before start-up.

#### QUANTITY OF FLUSHING LIQUID

| Seal Ø (mm) | 950 - 1780 RPM   | 2950 - 3500 RPM  | Pressure                                 |
|-------------|------------------|------------------|--|
| 35          | 1 litres / min   | 1.5 litres / min | 1 Bar higher than the operating pressure |
| 55          | 1.5 litres / min | 2.5 litres / min |  |
| 75          | 2 litres / min   | -                |  |

### 8.7 FLUSHING SYSTEM FOR DOUBLE SEAL: API PLAN 7353

**DESCRIPTION:** a pressurised, external liquid tank sends clean, cold liquid (+10° / +20°C) to the seal using forced circulation provided by a thermosiphon effect or pumping system.

**USE:** recommended for pumped liquids containing high concentrations of solids or crystals and for high temperatures.

**BENEFITS:** prevents the auxiliary liquid from becoming exposed to atmospheric pressure and guarantees zero emissions to the environment. A pressurised flushing system improves cleaning through the formation of a film between the surfaces of the seal rings.

**DISADVANTAGES:** the flushing circuit is complex and requires constant pressurisation. The auxiliary flushing liquid could become dispersed in the liquid pumped (compatibility of the two liquids must be checked). The pressurisation gas could dissolve in the auxiliary liquid. If the liquid pumped was dirty it could cause the flushing liquid to deteriorate, in which case it would have to be replaced regularly.

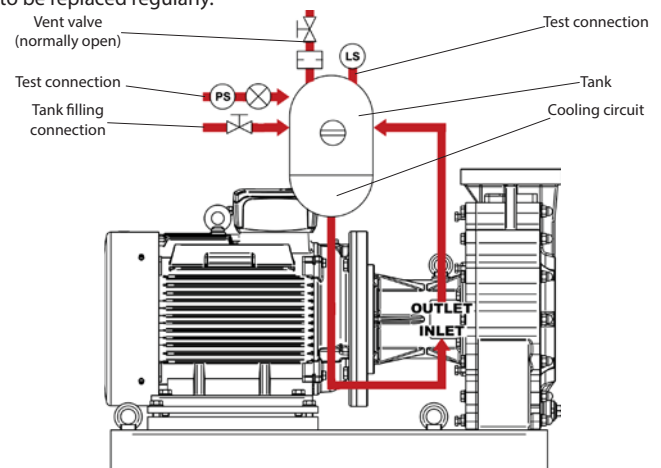

Some installation instructions are given here below:

- The tank must be as close as possible to the pump. A distance of 30 to 45 cm from the shaft axis is recommended. Installation of the tank at a distance of more than a metre is not recommended.
- The capacity of the tank must be consistent with the size of the pump. The minimum capacity should be at least 4 litres for every 25 mm of diameter of the pump shaft. Maintaining a minimum quantity of 8 litres.

- Provide a liquid cooling circuit.
- Install a closure valve on both the OUTLET and INLET piping running to the gland so that the tank can be isolated if the pipework needs replacing.
- Pipework should be installed perpendicular to the gland (vertically). If horizontal installation is the only option, make sure that the flushing pipe running to the gland has a gradient of 1° to 5° to prevent air pockets.
- INLET piping running to the seal must have a minimum diameter of 3/4", whilst the OUTLET piping must have a minimum diameter of 1/2".
- Avoid elbows or tight bends along the short stretch of piping.
- Liquid contained within the tank must be topped up at a height of more than 25 mm above the maximum level of liquid contained therein.
- Fit an alarm system that activates a solenoid valve in the event of insufficient pressure inside the inlet piping.
- Provide a drainage hole for emptying the tank.

**NOTE:** Flushing of the auxiliary liquid must be continuous, even during start-up and stopping.

 Vent the tank using a vent valve before start-up.

**QUANTITY OF FLUSHING LIQUID**

| Seal Ø (mm) | 950 - 1780 RPM   | 2950 - 3500 RPM  | Pressure                                 |
|-------------|------------------|------------------|--|
| 35          | 1 litres / min   | 1.5 litres / min | 1 Bar higher than the operating pressure |
| 55          | 1.5 litres / min | 2.5 litres / min |  |
| 75          | 2 litres / min   | -                |  |

**8.8 FLUSHING SYSTEM FOR DOUBLE SEAL: API PLAN 7354**

**DESCRIPTION:** pressurised, external flushing system. Clean, cold liquid (+10° / +20°C) is circulated by an external pump or pressure system.

**USE:** recommended for pumped liquids containing high concentrations of solids or crystals, high temperatures or high operating pressures.

**BENEFITS:** provides increased flow rate and greater heat dissipation. There is no tank to size and manage and the flushing circuit is simple.

**DISADVANTAGES:** the flushing liquid could become dispersed in the liquid pumped (compatibility of the two liquids must be checked). If the liquid pumped was dirty it could cause the flushing liquid to deteriorate, in which case it would have to be replaced regularly. Liquid consumption could be high and costly.

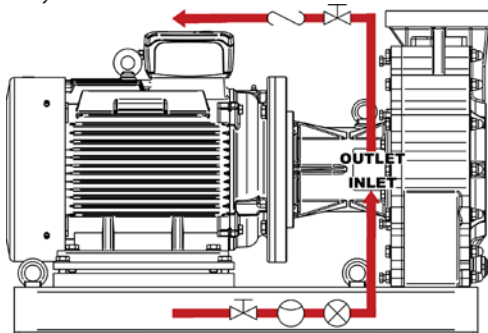

**NOTE:** Flushing of the auxiliary liquid must be continuous, even during start-up and stopping.

**QUANTITY OF FLUSHING LIQUID**

| Seal Ø (mm) | 950 - 1780 RPM   | 2950 - 3500 RPM  | Pressure                                 |
|-------------|------------------|------------------|--|
| 35          | 1 litres / min   | 1.5 litres / min | 1 Bar higher than the operating pressure |
| 55          | 1.5 litres / min | 2.5 litres / min |  |
| 75          | 2 litres / min   | -                |  |

## 9.0 OUTER DIMENSIONS

### 9.1 DIMENSIONS OF THE PUMP UNIT

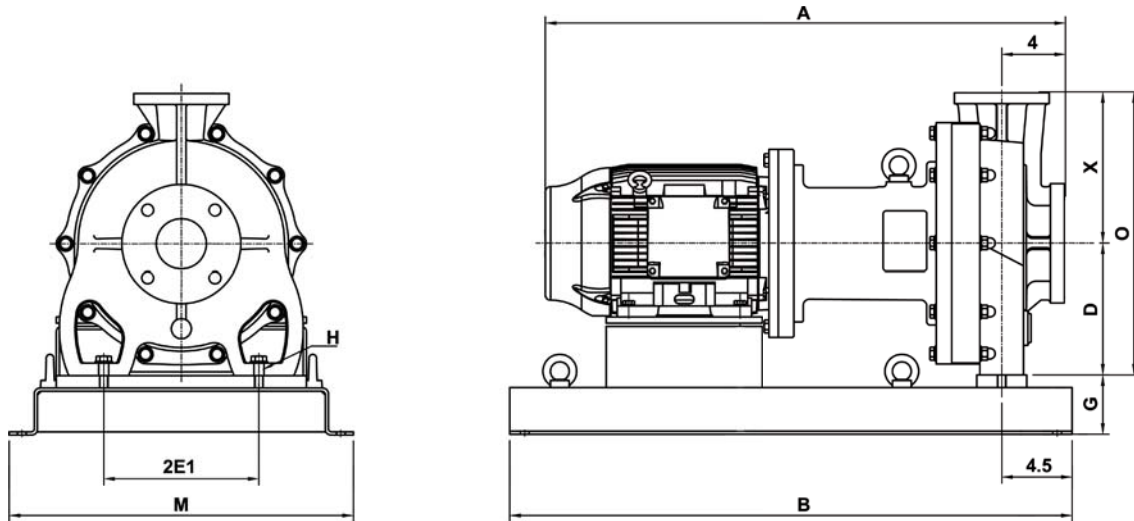

| Model                                  | Group | D             | H             | O              | X             |
|--|-------|---------------|---------------|----------------|---------------|
| 1.5x1x6 <sup>(1)</sup><br>(40x25x150)  | 1     | 5.25<br>(133) | 0.625<br>(16) | 11.75<br>(298) | 6.5<br>(165)  |
| 3x1.5x6<br>(80x40x150)                 | 1     | 5.25<br>(133) | 0.625<br>(16) | 11.75<br>(298) | 6.5<br>(165)  |
| 1.5x1x8 <sup>(1)</sup><br>(40x25x200)  | 1     | 5.25<br>(133) | 0.625<br>(16) | 11.75<br>(298) | 6.5<br>(165)  |
| 3x2x6<br>(80x50x150)                   | 1     | 5.25<br>(133) | 0.625<br>(16) | 11.75<br>(298) | 6.5<br>(165)  |
| 3x1.5x8<br>(80x40x200)                 | 2     | 8.25<br>(210) | 0.625<br>(16) | 16.5<br>(420)  | 8.25<br>(210) |
| 3x2x8<br>(80x50x200)                   | 2     | 8.25<br>(210) | 0.625<br>(16) | 17.75<br>(450) | 9.5<br>(242)  |
| 4x3x8 <sup>(2)</sup><br>(100x80x200)   | 2     | 8.25<br>(210) | 0.625<br>(16) | 19.25<br>(490) | 11<br>(280)   |
| 3x1.5x10<br>(80x40x250)                | 2     | 8.25<br>(210) | 0.625<br>(16) | 16.75<br>(425) | 8.5<br>(216)  |
| 3x2x10<br>(80x50x250)                  | 2     | 8.25<br>(210) | 0.625<br>(16) | 17.75<br>(450) | 9.5<br>(242)  |
| 4x3x10 <sup>(2)</sup><br>(100x80x250)  | 2     | 8.25<br>(210) | 0.625<br>(16) | 19.25<br>(490) | 11<br>(280)   |
| 6x4x10 <sup>(2)</sup><br>(150x100x250) | 2     | 10<br>(254)   | 0.625<br>(16) | 23.5<br>(597)  | 13.5<br>(343) |
| 6x4x13 <sup>(2)</sup><br>(150x100x330) | 2     | 10<br>(254)   | 0.625<br>(16) | 23.5<br>(597)  | 13.5<br>(343) |

|                  | IEC frame    | NEMA frame | A <sup>(1)</sup> | B            | 2E1           | G               | M           |
|------------------|--------------|------------|------------------|--------------|---------------|-----------------|-------------|
| GROUP 1          | 90L          | 145        | 25.67<br>(652)   | 27<br>(686)  | 6<br>(152)    | 2.625<br>(66.7) | 17<br>(432) |
|                  | 100L<br>112M | -<br>184   | 28.42<br>(722)   | 30<br>(762)  | 6<br>(152)    | 2.625<br>(66.7) | 19<br>(483) |
|                  | 132S<br>132M | 213<br>215 | 31.97<br>(812)   | 37<br>(940)  | 6<br>(152)    | 2.875<br>(73)   | 22<br>(559) |
|                  | 160M<br>160L | 254<br>256 | 37.28<br>(947)   | 40<br>(1016) | 6<br>(152)    | 4.75<br>(121)   | 25<br>(635) |
|                  | 200L         | 326        | 41.22<br>(1047)  | 43<br>(1092) | 6<br>(152)    | 5.5<br>(140)    | 29<br>(737) |
| GROUP 2 (D=8.25) | 90L          | 145        | 29.01<br>(737)   | 30<br>(762)  | 9.75<br>(248) | 4<br>(102)      | 21<br>(533) |
|                  | 100L<br>112M | -<br>184   | 30.31<br>(770)   | 32<br>(813)  | 9.75<br>(248) | 4<br>(102)      | 21<br>(533) |
|                  | 132S<br>132M | 213<br>215 | 34.84<br>(885)   | 40<br>(1016) | 9.75<br>(248) | 4<br>(102)      | 22<br>(559) |
|                  | 160M<br>160L | 254<br>256 | 39.96<br>(1015)  | 43<br>(1092) | 9.75<br>(248) | 4<br>(102)      | 25<br>(635) |
|                  | 200L<br>225M | 326<br>365 | 44.88<br>(1140)  | 47<br>(1194) | 9.75<br>(248) | 4<br>(102)      | 29<br>(737) |
|                  | 280S<br>280M | 444<br>445 | 53.35<br>(1355)  | 60<br>(1524) | 9.75<br>(248) | 6<br>(152)      | 34<br>(864) |
|                  | 315S         | 449        | 63.58<br>(1615)  | 65<br>(1651) | 9.75<br>(248) | 6.5<br>(165)    | 38<br>(965) |
| GROUP 2 (D=10)   | 132S<br>132M | 213<br>215 | 34.84<br>(885)   | 40<br>(1016) | 9.75<br>(248) | 4<br>(102)      | 22<br>(559) |
|                  | 160M<br>160L | 254<br>256 | 39.96<br>(1015)  | 43<br>(1092) | 9.75<br>(248) | 4<br>(102)      | 25<br>(635) |
|                  | 200L<br>225M | 326<br>365 | 44.88<br>(1140)  | 47<br>(1194) | 9.75<br>(248) | 4<br>(102)      | 29<br>(737) |
|                  | 280S<br>280M | 444<br>445 | 53.35<br>(1355)  | 60<br>(1524) | 9.75<br>(248) | 6<br>(152)      | 34<br>(864) |
|                  | 315S         | 449        | 63.58<br>(1615)  | 65<br>(1651) | 9.75<br>(248) | 6.5<br>(165)    | 38<br>(965) |

#### GENERAL NOTES:

- (a) Dimensions in parentheses are approximate equivalents in millimeters.  
 (b) all other dimensions are in inches.

#### NOTES:

- (1) Suction flange has tapped bolts holes.  
 (2) Discharge flange has tapped bolts holes.

#### NOTE:

In order to receive the specific dimensional drawings please send a request to AFFETTI.









COSTUMER FOCUSED



CARE IN RESEARCH & DESIGN



CUTTING-EDGE TECHNOLOGY



SPECIAL RAW MATERIALS



APPLICATION FIELD



FUNCTIONAL TESTING



SHIPPING SOLUTIONS



**YOUR  
SOLUTIONS**

C O R R O S I V E   A P P L I C A T I O N S

AFFETTI PUMPS s.r.l.  
Via P. Maroncelli, 4  
21053 CASTELLANZA (VA)

tel. (+39) 331-503358 (+39) 331-505595  
fax. (+39) 331-483007  
Sales Department: [eaquila@affetti.com](mailto:eaquila@affetti.com)  
Technical Department: [mcassaniti@affetti.com](mailto:mcassaniti@affetti.com)  
Web-site: [www.affetti.com](http://www.affetti.com)

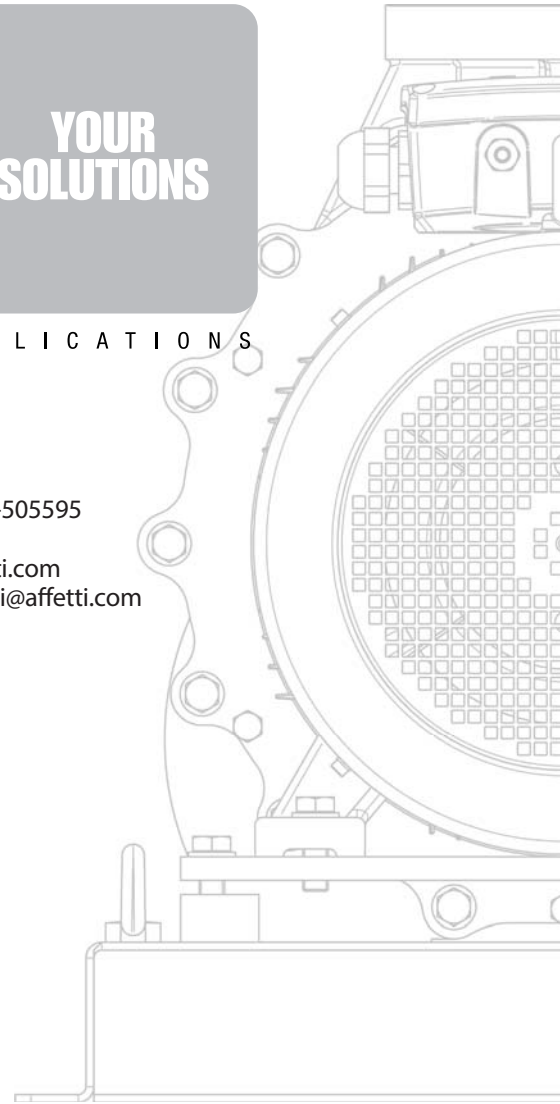

Authorized distributor

All rights reserved. Reproduction, copying or transmittal of this manual and its contents are strictly prohibited without prior authorisation from the manufacturer.